

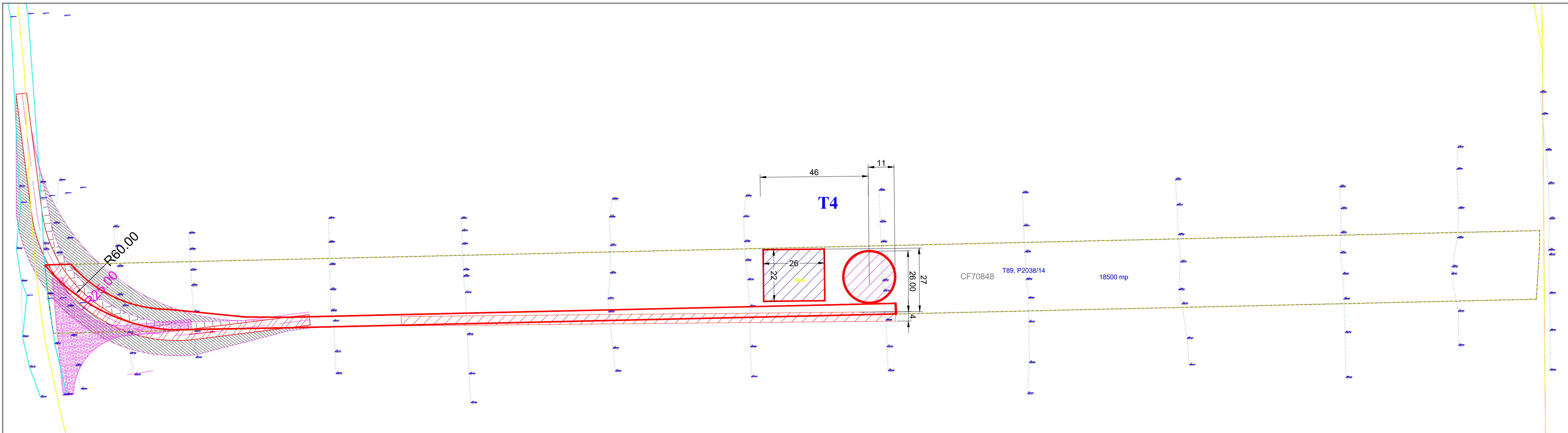





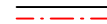

Legenda / Legend	
	LIMITA PROPRIETATII
	DRUMURI EXISTENTE
	CALE DE ACCES AMENAJATA CU PIATRA SPARTA
	PLATFORMA MONTAJ PENTRU MACARA DIN BETON DE CIMENT
	FUNDATIE TURBINA TIP SG 6.6 H= 155 m, diametru rotor 170 m;

Verificator	NUME	CERINTA	Referat de verificare	Semnătura: Număr:	Data:
S.C. BDP CONSTRUCT S.R.L. J22/1685/2014, CIF RO33764349 Iasi, Bd. Socola, nr. 34		DENUMIREA PROIECTULUI: "PARC EOLIAN HOCENI - DIMITRIE CANTEMIR"			PROIECT Nr. 1224/2022 Faza: PUZ/DTAC
		AMPLASAMENT: Comuna Hoceni-Comuna Dimitrie Cantemir, Judetul Vaslui BENEFICIAR: SC OMNIENERGY PRODUCTION SRL			
SEF PROIECT	Ing. Bodoș Dragoș Andrei		SCARA 1:1000	PLAN DE SITUATIE TURBINA T2	
PROIECTAT	Ing. Craciun Eugeniu		DATA 2022		
DESENAT	Ing. Murariu Vlad-Alexandru				

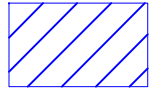
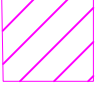

Legenda / Legend

	LIMITA PROPRIETATII
	DRUMURI EXISTENTE
	CALE DE ACCES AMENAJATA CU PIATRA SPARTA
	PLATFORMA MONTAJ PENTRU MACARA DIN BETON DE CIMENT
	FUNDATIE TURBINA TIP SG 6.6 H= 155 m, diametru rotor 170 m;

Verificator	NUME	CERINTA	Referat de verificare	Semnătura: Număr:	Data:	
 S.C. BDP CONSTRUCT S.R.L. <small>J22/1685/2014, CIF RO33764349 Iasi, Bd. Socola, nr. 34</small>		DENUMIREA PROIECTULUI:			PROIECT Nr. 1224/2022	
		"PARC EOLIAN HOCENI - DIMITRIE CANTEMIR"				
		AMPLASAMENT: Comuna Hocenii-Comuna Dimitrie Cantemir, Judetul Vaslui			Faza: PUZ/DTAC	
		BENEFICIAR: SC OMNIENERGY PRODUCTION SRL				
		DENUMIRE PLANȘĂ:			PLANSĂ A03	
SEF PROIECT	Ing. Bodoga Dragoș Andrei		SCARA 1:1000	PLAN DE SITUATIE TURBINA T4		
PROIECTAT	Ing. Craciun Eugeniu		DATA 2022			
DESENAT	Ing. Murariu Vlad-Alexandru					

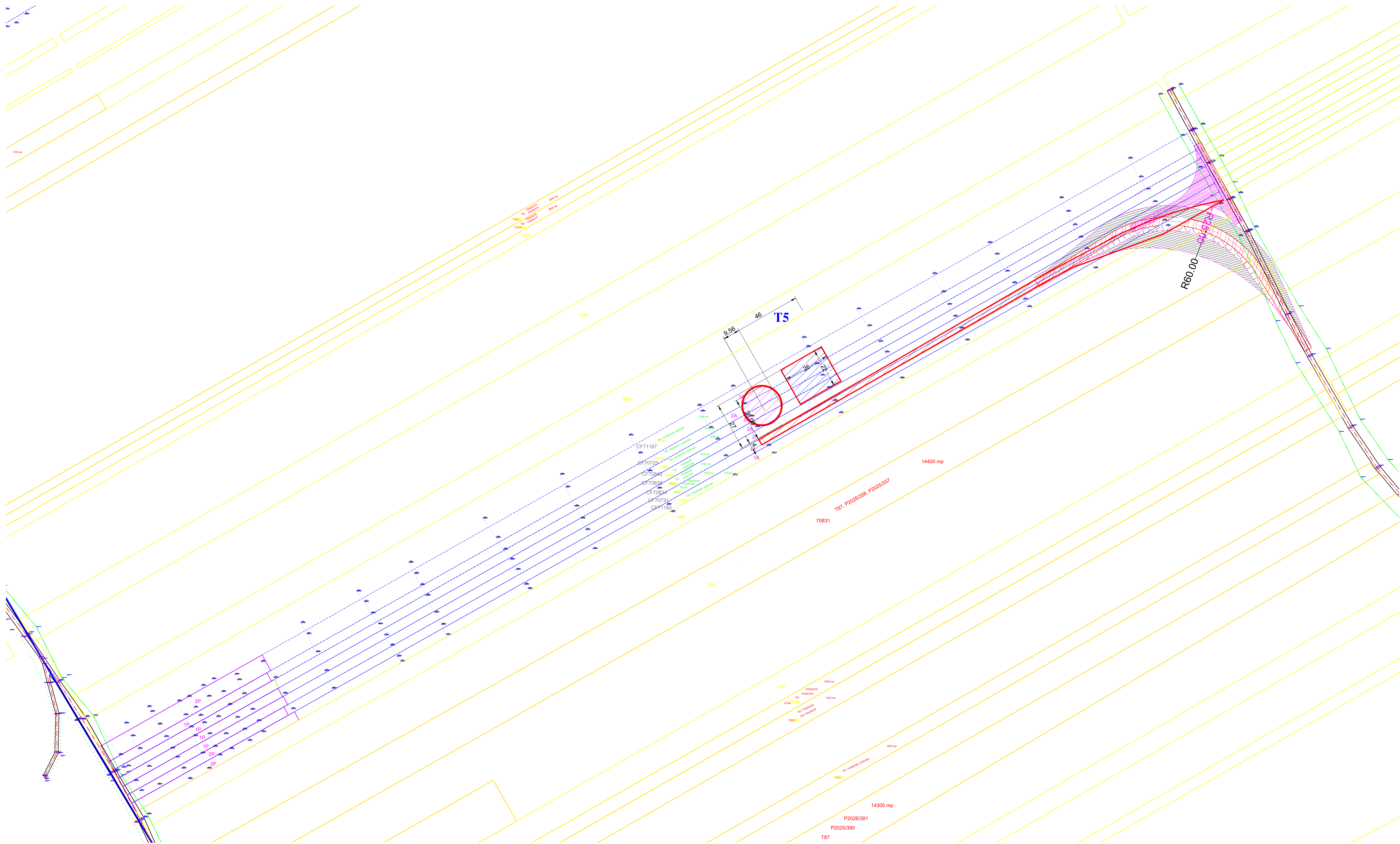

Legenda / Legend

	LIMITA PROPRIETATII
	DRUMURI EXISTENTE
	CALE DE ACCES AMENAJATA CU PIATRA SPARTA
	PLATFORMA MONTAJ PENTRU MACARA DIN BETON DE CIMENT
	FUNDATIE TURBINA TIP SG 6.6 H= 155 m, diametru rotor 170 m;

Verificator	NUME	CERINTA	Referat de verificare	Semnătura:	Data:
				Număr:	
S.C. BDP CONSTRUCT S.R.L. <small>J221685/2014, CIF RO33764349 Iasi, Bd. Socola, nr. 34</small>		DENUMIREA PROIECTULUI: "PARC EOLIAN HOCENI - DIMITRIE CANTEMIR" AMPLASAMENT: Comuna Hocenii-Comuna Dimitrie Cantemir, Judetul Vaslui BENEFICIAR: SC OMNIENERGY PRODUCTION SRL DENUMIRE PLANȘĂ:			PROIECT Nr. 1224/2022 Faza: PUZ/DTAC PLANȘA A04
SEF PROIECT	Ing. Bogdan Dragoș Andrei	SCARA	1:1000		
PROIECTAT	Ing. Craciun Eugeniu	DATA	2022		
DESENAȚ	Ing. Murariu Vlad-Alexandru				

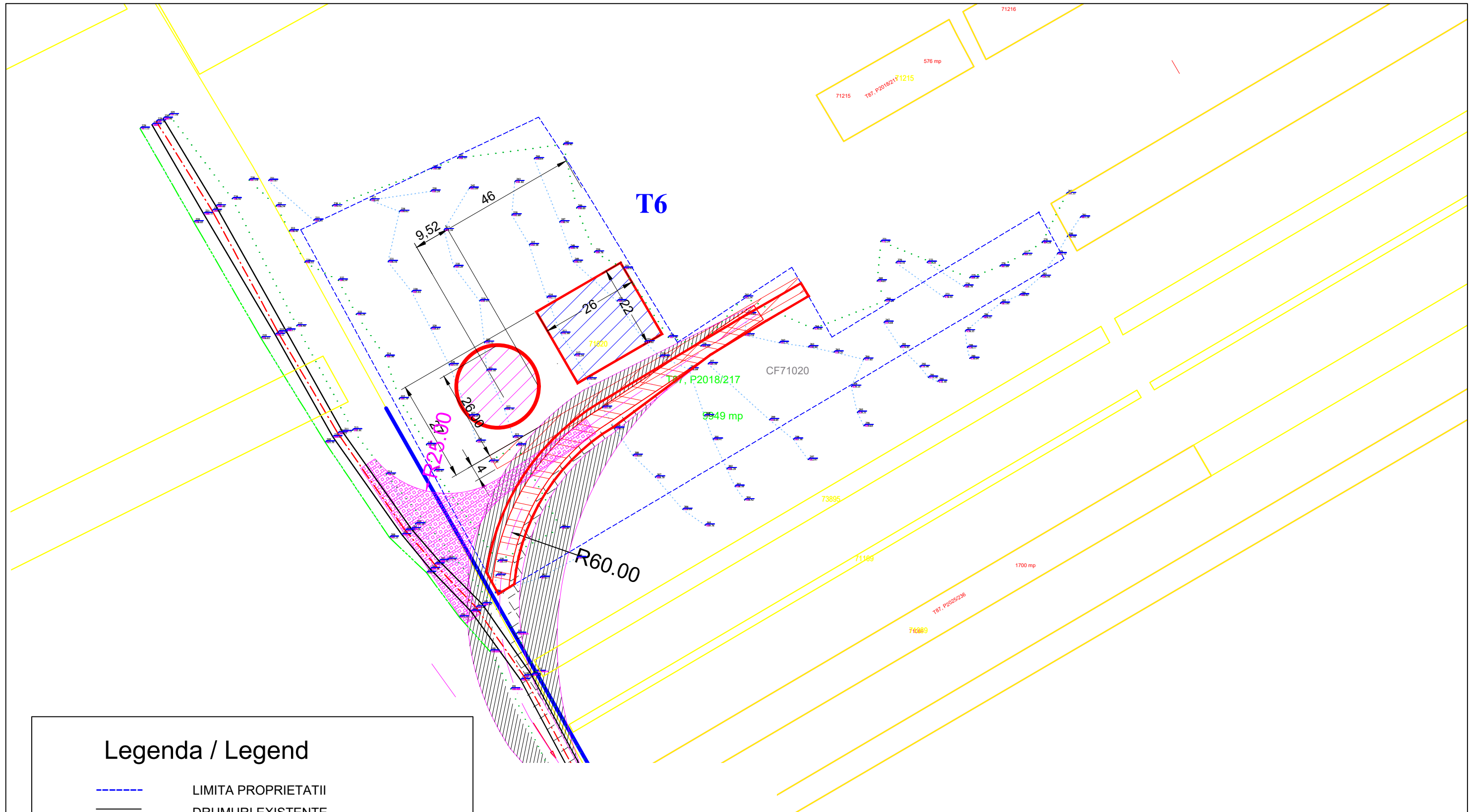

Legenda / Legend

- LIMITA PROPRIETATII
- DRUMURI EXISTENTE
- CALE DE ACCES AMENAJATA CU PIATRA SPARTA
- PLATFORMA MONTAJ PENTRU MACARA DIN BETON DE CIMENT
- FUNDATIE TURBINA TIP SG 6.6 H= 155 m, diametru rotor 170 m;

Verificator	NUME	CERINTA	Referat de verificare	Semnătura: Număr:	Data:
S.C. BDP CONSTRUCT S.R.L. <small>J22/1685/2014, CIF RO33764349 Iasi, Bd. Socola, nr. 34</small>			DENUMIREA PROIECTULUI:		PROIECT Nr. 1224/2022 Faza: PUZ/DTAC PLANSA A05
			"PARC EOLIAN HOCENI - DIMITRIE CANTEMIR"		
			AMPLASAMENT:		
			Comuna Hoceni-Comuna Dimitrie Cantemir, Judetul Vaslui		
			BENEFICIAR: SC OMNIENERGY PRODUCTION SRL		
			DENUMIRE PLANȘĂ:		
			PLAN DE SITUATIE TURBINA T6		
SEF PROIECT	Ing. Bodoș Dragoș Andrei		SCARA 1:1000		
PROIECTAT	Ing. Craciun Eugeniu		DATA 2022		
DESENAT	Ing. Murariu Vlad-Alexandru				

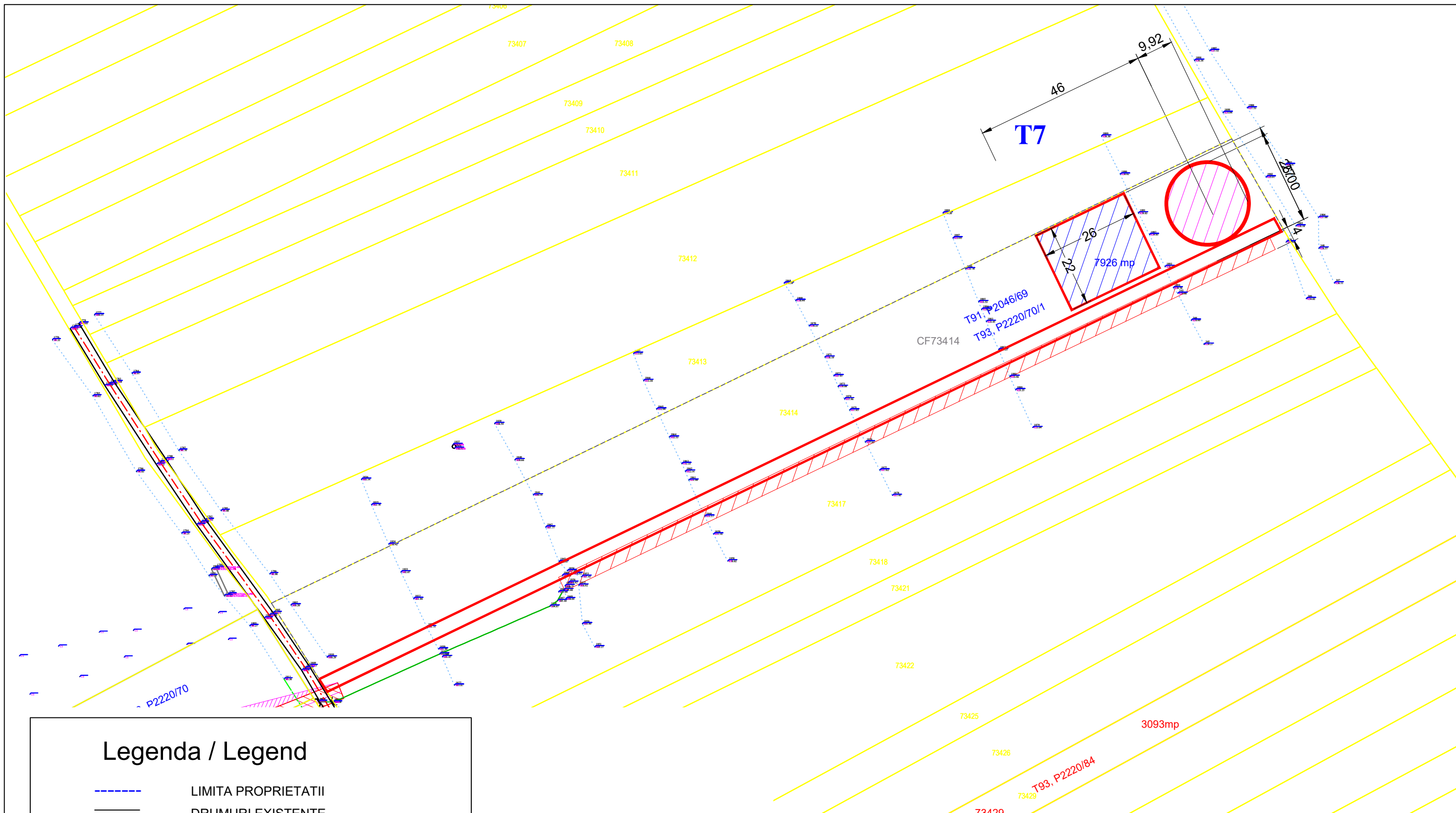

Legenda / Legend	
	LIMITA PROPRIETATII
	DRUMURI EXISTENTE
	CALE DE ACCES AMENAJATA CU PIATRA SPARTA
	PLATFORMA MONTAJ PENTRU MACARA DIN BETON DE CIMENT
	FUNDATIE TURBINA TIP SG 6.6 H= 155 m, diametru rotor 170 m;

Verificator	NUME	CERINTA	Referat de verificare	Semnătura: Număr:	Data:
S.C. BDP CONSTRUCT S.R.L. J22/1685/2014, CIF RO33764349 Iasi, Bd. Socola, nr. 34		DENUMIREA PROIECTULUI:			PROIECT Nr. 1224/2022
		"PARC EOLIAN HOCENI - DIMITRIE CANTEMIR" AMPLASAMENT: Comuna Hoceni-Comuna Dimitrie Cantemir, Judetul Vaslui BENEFICIAR: SC OMNIENERGY PRODUCTION SRL			
SEF PROIECT	Ing. Bodoș Dragoș Andrei		SCARA 1:1000	PLAN DE SITUATIE TURBINA T7 Faza: PUZ/DTAC PLANSA A06	
PROIECTAT	Ing. Craciun Eugeniu		DATA 2022		
DESENAT	Ing. Murariu Vlad-Alexandru				

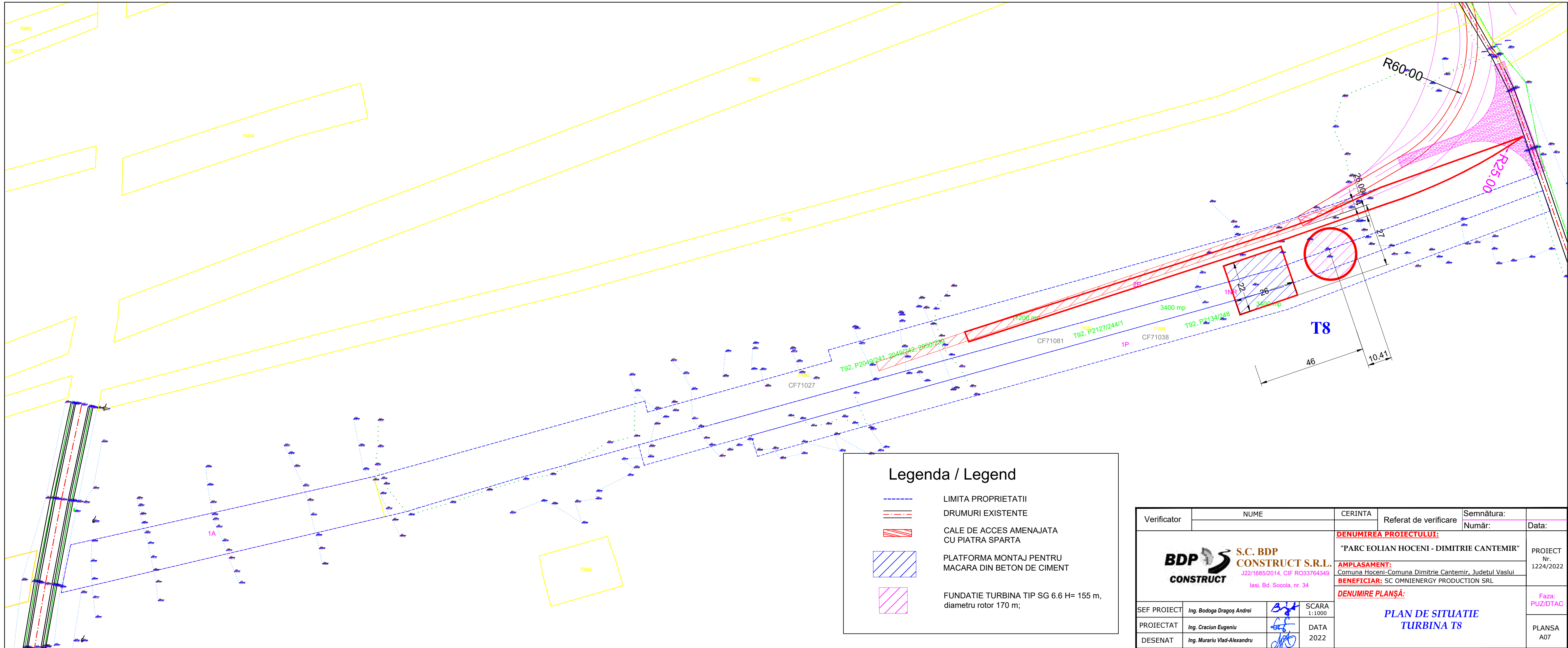





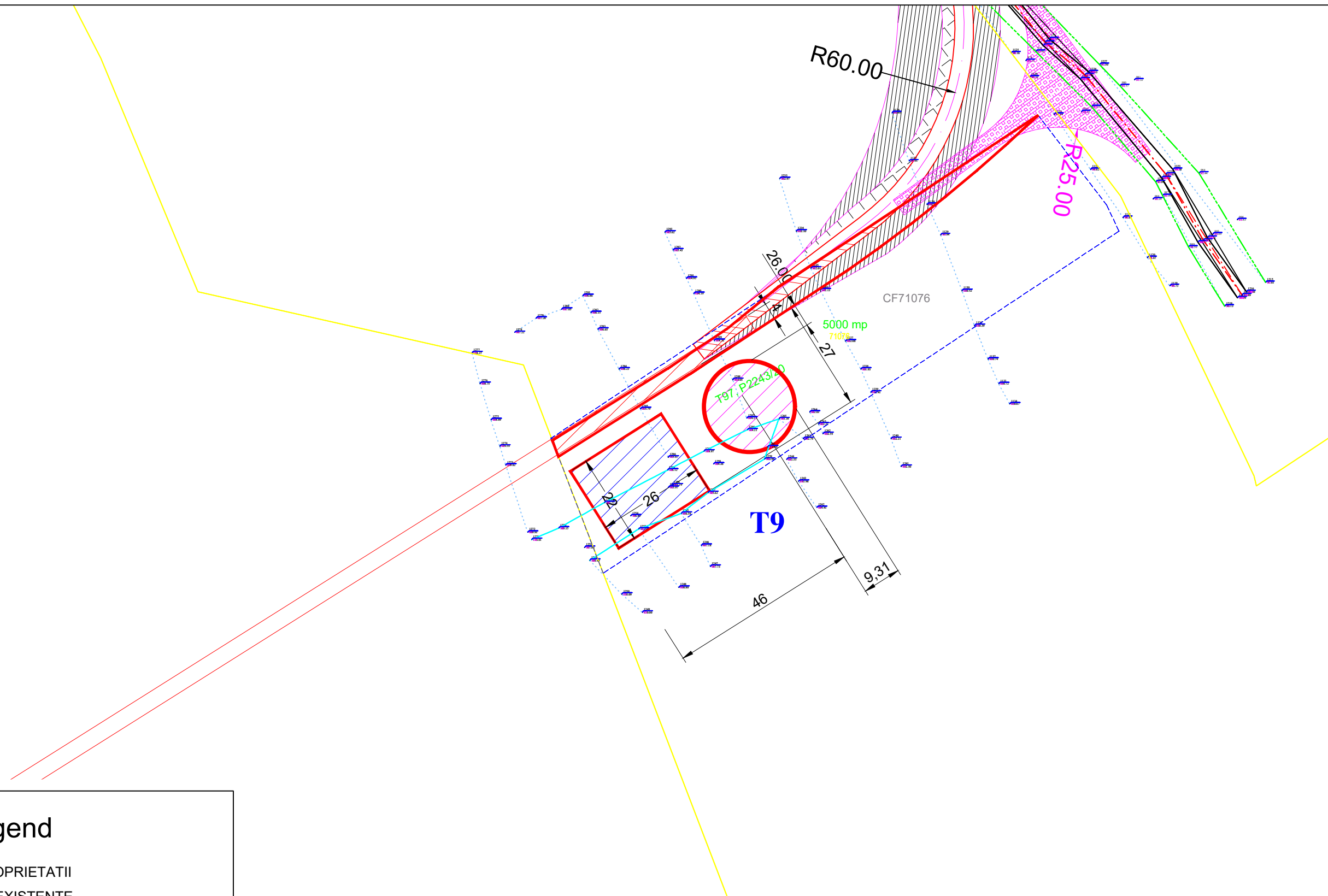

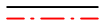

Legenda / Legend	
	LIMITA PROPRIETATII
	DRUMURI EXISTENTE
	CALE DE ACCES AMENAJATA CU PIATRA SPARTA
	PLATFORMA MONTAJ PENTRU MACARA DIN BETON DE CIMENT
	FUNDATIE TURBINA TIP SG 6.6 H= 155 m, diametru rotor 170 m;

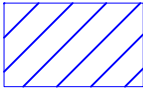
Verificator	NUME	CERINTA	Referat de verificare	Semnătura: Număr:	Data:
S.C. BDP CONSTRUCT S.R.L. J22/1685/2014, CIF R033764349 Iasi, Bd. Socola, nr. 34		DENUMIREA PROIECTULUI:			PROIECT Nr. 1224/2022
		"PARC EOLIAN HOCENI - DIMITRIE CANTEMIR"			
		AMPLASAMENT:			Faza: PUZ/DTAC
		Comuna Hocenii-Comuna Dimitrie Cantemir, Judetul Vaslui			
		BENEFICIAR: SC OMNIENERGY PRODUCTION SRL			PLANSA A07
		DENUMIRE PLANȘĂ:			
		PLAN DE SITUATIE TURBINA T8			
SEF PROIECT	Ing. Bodoga Dragoș Andrei		SCARA 1:1000		
PROIECTAT	Ing. Craciun Eugeniu		DATA 2022		
DESENAT	Ing. Murariu Vlad-Alexandru				



Legenda / Legend

-  LIMITA PROPRIETATII
-  DRUMURI EXISTENTE
-  CALE DE ACCES AMENAJATA CU PIATRA SPARTA
-  PLATFORMA MONTAJ PENTRU MACARA DIN BETON DE CIMENT
-  FUNDATIE TURBINA TIP SG 6.6 H= 155 m, diametru rotor 170 m;

Verificator	NUME	CERINTA	Referat de verificare	Semnătura: Număr:	Data:
 S.C. BDP CONSTRUCT S.R.L. J22/1685/2014, CIF RO33764349 Iasi, Bd. Socola, nr. 34		DENUMIREA PROIECTULUI:			PROIECT Nr. 1224/2022
		"PARC EOLIAN HOCENI - DIMITRIE CANTEMIR" AMPLASAMENT: Comuna Hoceni-Comuna Dimitrie Cantemir, Judetul Vaslui BENEFICIAR: SC OMNIENERGY PRODUCTION SRL			
SEF PROIECT		Ing. Bodoaga Dragoş Andrei		SCARA 1:1000	PLAN DE SITUATIE TURBINA T9 Faza: PUZ/DTAC PLANSA A08
PROIECTAT		Ing. Craciun Eugeniu		DATA 2022	
DESENAT		Ing. Murariu Vlad-Alexandru			

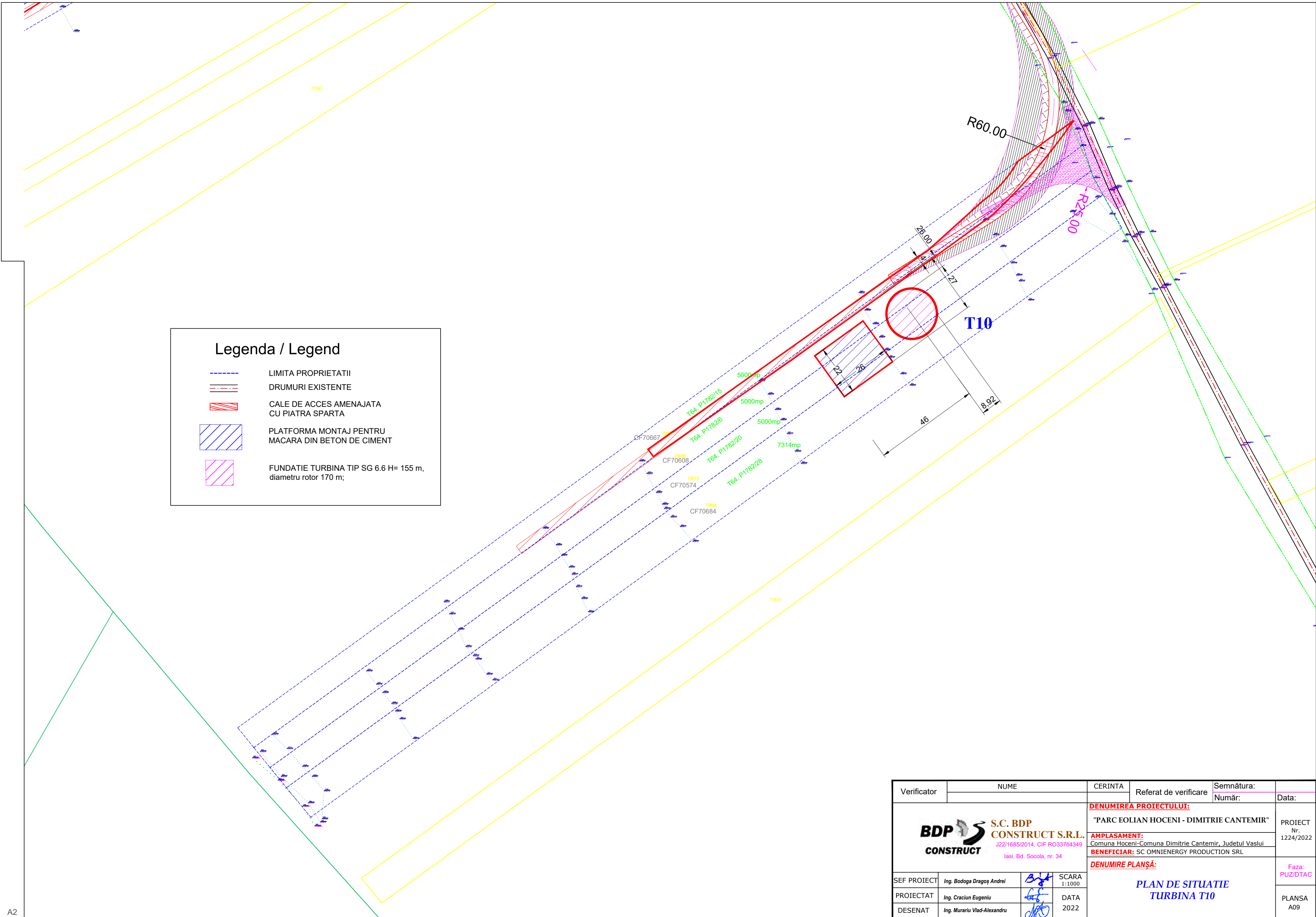

Legenda / Legend	
	LIMITA PROPRIETATII
	DRUMURI EXISTENTE
	CALE DE ACCES AMENAJATA CU PIATRA SPARTA
	PLATFORMA MONTAJ PENTRU MACARA DIN BETON DE CIMENT
	FUNDATIE TURBINA TIP SG 6.6 H= 155 m, diametru rotor 170 m;

Verificator	NUME	CERINTA	Referat de verificare	Semnătura: Număr:	Data:
S.C. BDP CONSTRUCT S.R.L. J22/1685/2014, CIF RO33764349 Iasi, Bd. Socola, nr. 34		DENUMIREA PROIECTULUI: "PARC EOLIAN HOCENI - DIMITRIE CANTEMIR"			PROIECT Nr. 1224/2022
		AMPLASAMENT: Comuna Hocenii-Comuna Dimitrie Cantemir, Judetul Vaslui BENEFICIAR: SC OMNIENERGY PRODUCTION SRL			Faza: PUZ/DTAC
DENUMIRE PLANȘĂ: PLAN DE SITUATIE TURBINA T10					PLANSA A09
SEF PROIECT	Ing. Bodoga Dragoș Andrei		SCARA 1:1000		
PROIECTAT	Ing. Craciun Eugeniu		DATA 2022		
DESENAT	Ing. Murariu Vlad-Alexandru				

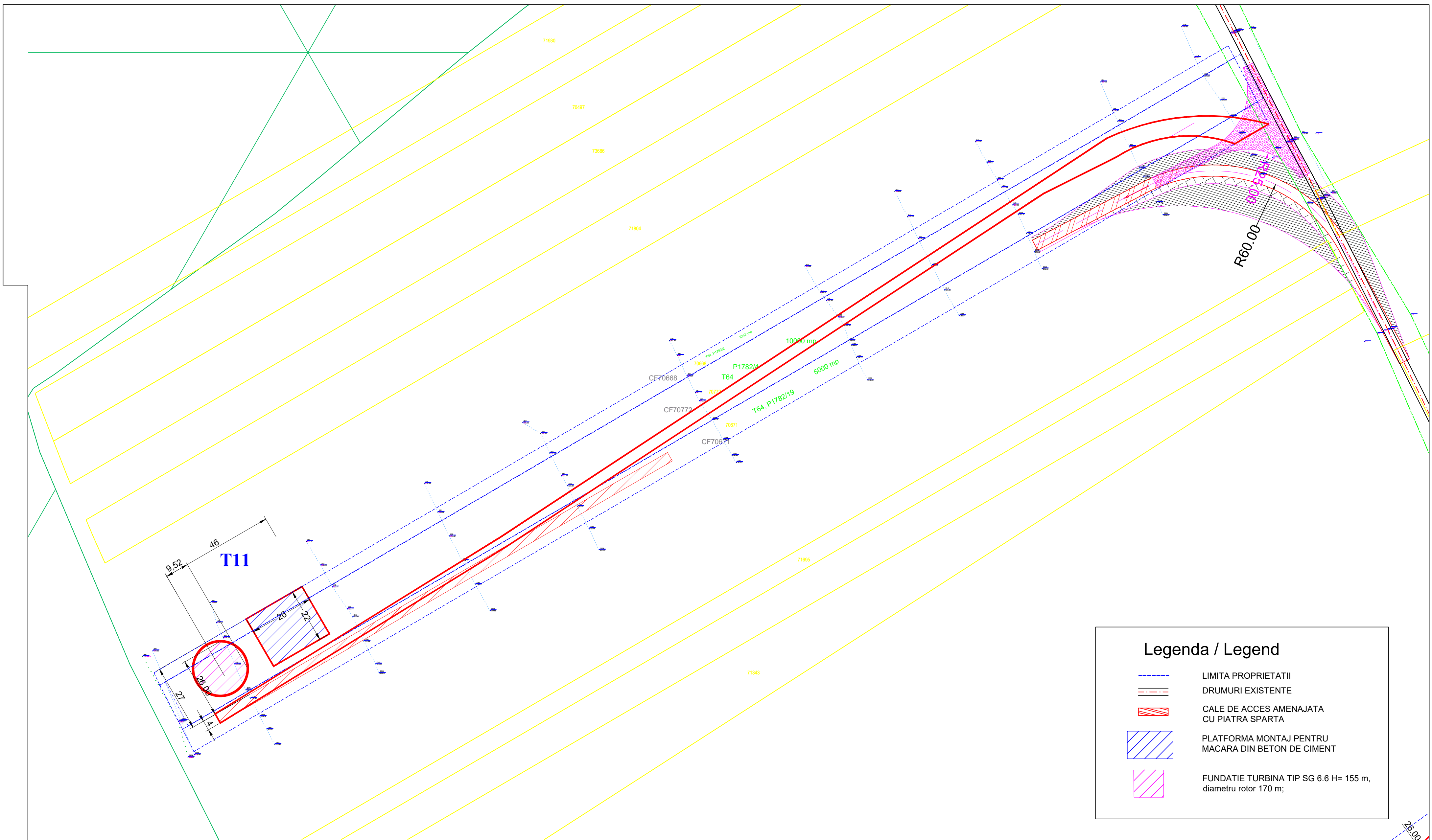

Legenda / Legend

- LIMITA PROPRIETATII
- DRUMURI EXISTENTE
- CALE DE ACCES AMENAJATA CU PIATRA SPARTA
- ▨ PLATFORMA MONTAJ PENTRU MACARA DIN BETON DE CIMENT
- ▨ FUNDATIE TURBINA TIP SG 6.6 H= 155 m, diametru rotor 170 m;

Verificator	NUME	CERINTA	Referat de verificare	Semnătura: Număr:	Data:
S.C. BDP CONSTRUCT S.R.L. <small>J22/1685/2014, CIF RO33764349 Iasi, Bd. Socola, nr. 34</small>		DENUMIREA PROIECTULUI: "PARC EOLIAN HOCENI - DIMITRIE CANTEMIR" AMPLASAMENT: Comuna Hocenii-Comuna Dimitrie Cantemir, Judetul Vaslui BENEFICIAR: SC OMNIENERGY PRODUCTION SRL			PROIECT Nr. 1224/2022
		DENUMIRE PLANȘĂ: PLAN DE SITUATIE TURBINA T11			Faza: PUZDTAC
SEF PROIECT	Ing. Bodoga Dragoș Andrei	SCARA 1:1000	DATA 2022		
PROIECTAT	Ing. Craciun Eugeniu				
DESENAT	Ing. Murariu Vlad-Alexandru				

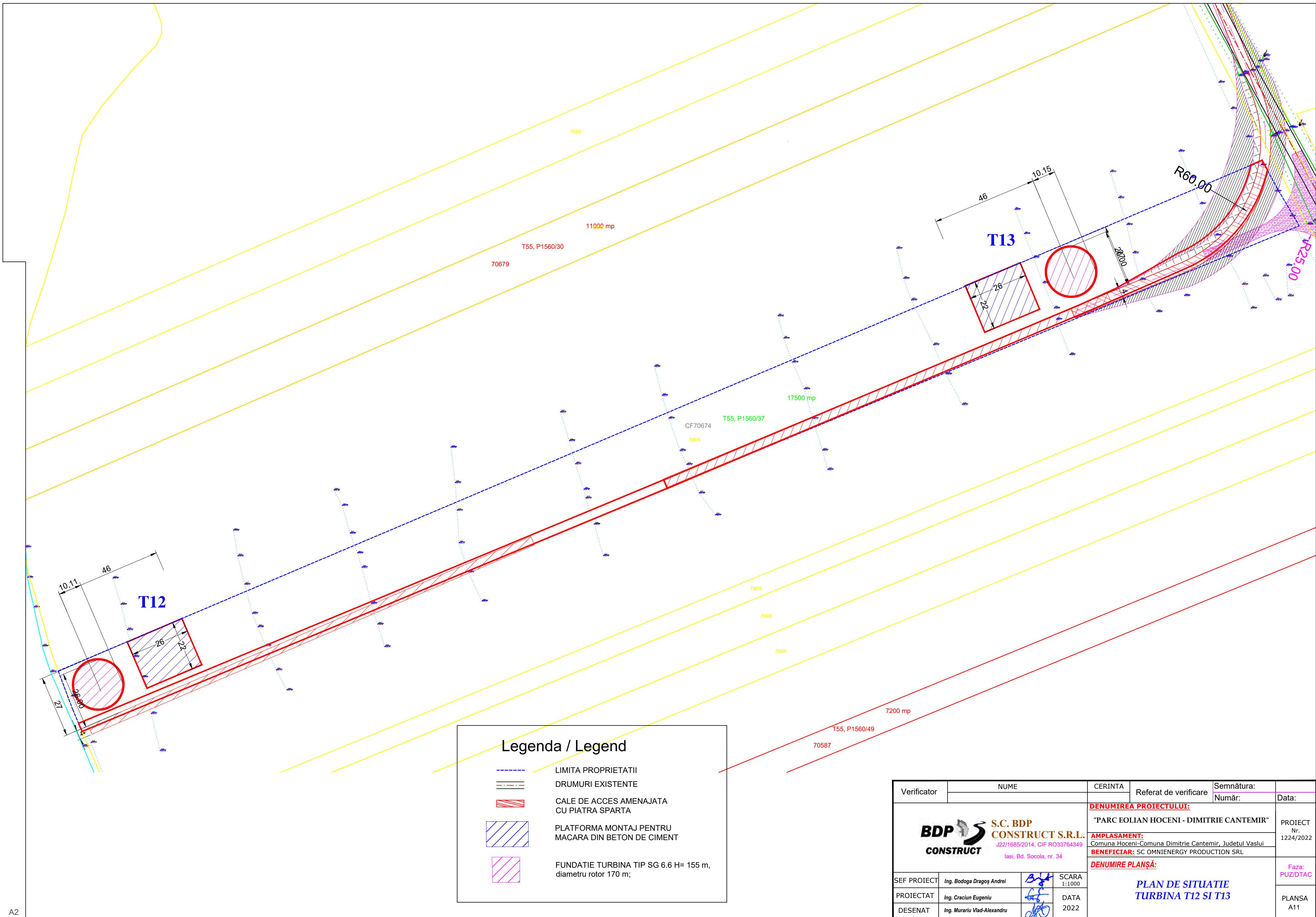



Legenda / Legend



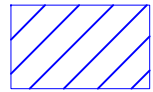
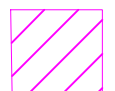

	LIMITA PROPRIETATII
	DRUMURI EXISTENTE
	CALE DE ACCES AMENAJATA CU PIATRA SPARTA
	PLATFORMA MONTAJ PENTRU MACARA DIN BETON DE CIMENT
	FUNDATIE TURBINA TIP SG 6.6 H= 155 m, diametru rotor 170 m;

Verificator	NUME	CERINTA	Referat de verificare	Semnătura:	Data:
				Număr:	
S.C. BDP CONSTRUCT S.R.L. J22/1685/2014, CIF RO33764349 Iasi, Bd. Socola, nr. 34		DENUMIREA PROIECTULUI: "PARC EOLIAN HOCENI - DIMITRIE CANTEMIR"			PROIECT Nr. 1224/2022
		AMPLASAMENT: Comuna Hocenii-Comuna Dimitrie Cantemir, Judetul Vaslui BENEFICIAR: SC OMNIENERGY PRODUCTION SRL			Faza: PUZ/DTAC
DENUMIRE PLANȘĂ: PLAN DE SITUATIE TURBINA T12 SI T13					PLANSA A11
SEF PROIECT	Ing. Bodoga Dragoș Andrei		SCARA 1:1000		
PROIECTAT	Ing. Craciun Eugeniu		DATA 2022		
DESENAT	Ing. Murariu Vlad-Alexandru				

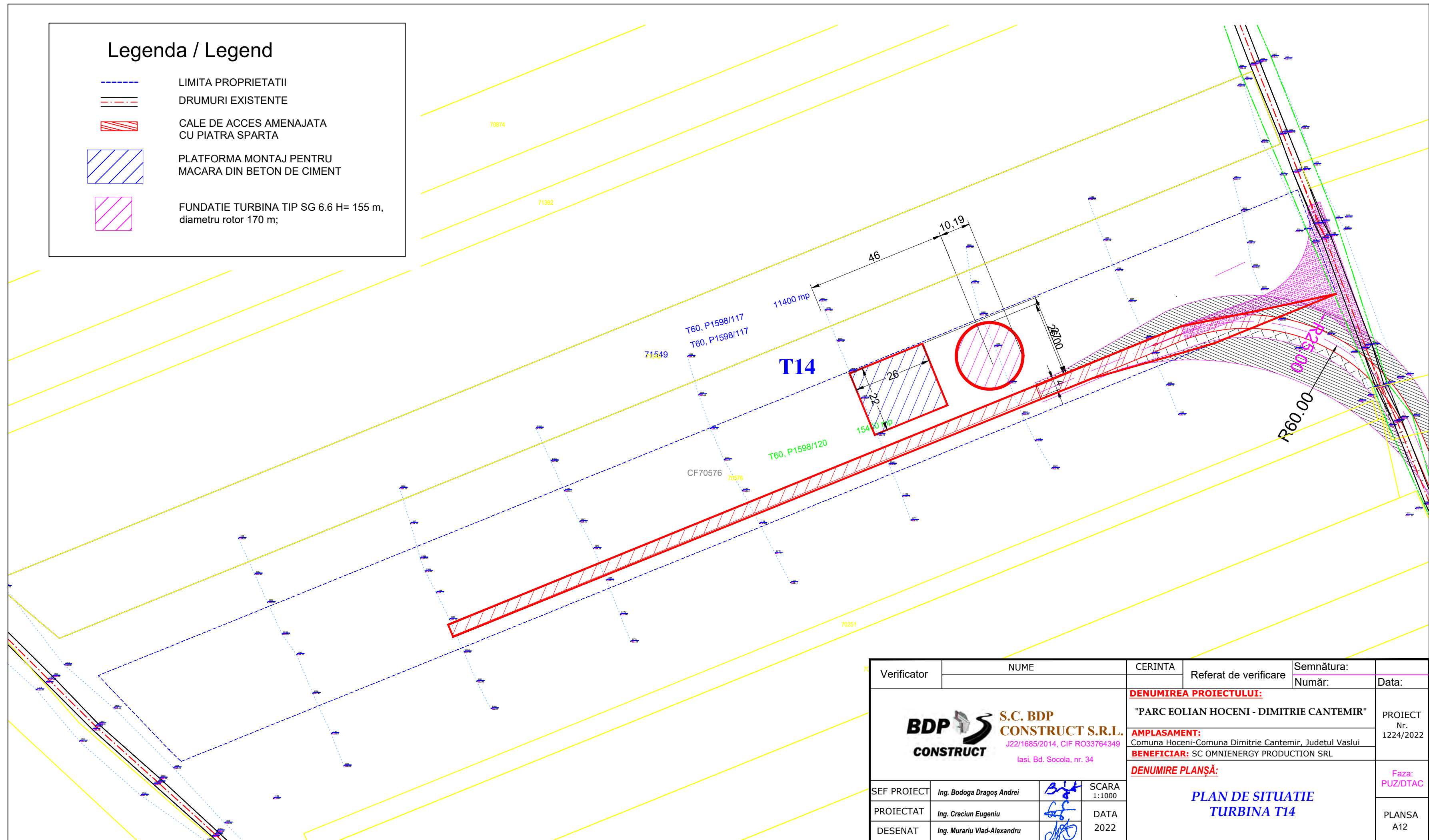
Legenda / Legend

-  LIMITA PROPRIETATII
-  DRUMURI EXISTENTE
-  CALE DE ACCES AMENAJATA CU PIATRA SPARTA
-  PLATFORMA MONTAJ PENTRU MACARA DIN BETON DE CIMENT
-  FUNDATIE TURBINA TIP SG 6.6 H= 155 m, diametru rotor 170 m;



Verificator	NUME		CERINTA	Referat de verificare	Semnătura:	Data:
					Număr:	
 S.C. BDP CONSTRUCT S.R.L. J22/1685/2014, CIF RO33764349 Iasi, Bd. Socola, nr. 34			DENUMIREA PROIECTULUI: "PARC EOLIAN HOCENI - DIMITRIE CANTEMIR"		PROIECT Nr. 1224/2022	
			AMPLASAMENT: Comuna Hoceni-Comuna Dimitrie Cantemir, Judetul Vaslui BENEFICIAR: SC OMNIENERGY PRODUCTION SRL			
SEF PROIECT <i>Ing. Bodoga Dragoș Andrei</i>  SCARA 1:1000 PROIECTAT <i>Ing. Craciun Eugeniu</i>  DATA 2022 DESENAT <i>Ing. Murariu Vlad-Alexandru</i> 			DENUMIRE PLANȘĂ: PLAN DE SITUATIE TURBINA T14		Faza: PUZ/DTAC PLANSA A12	

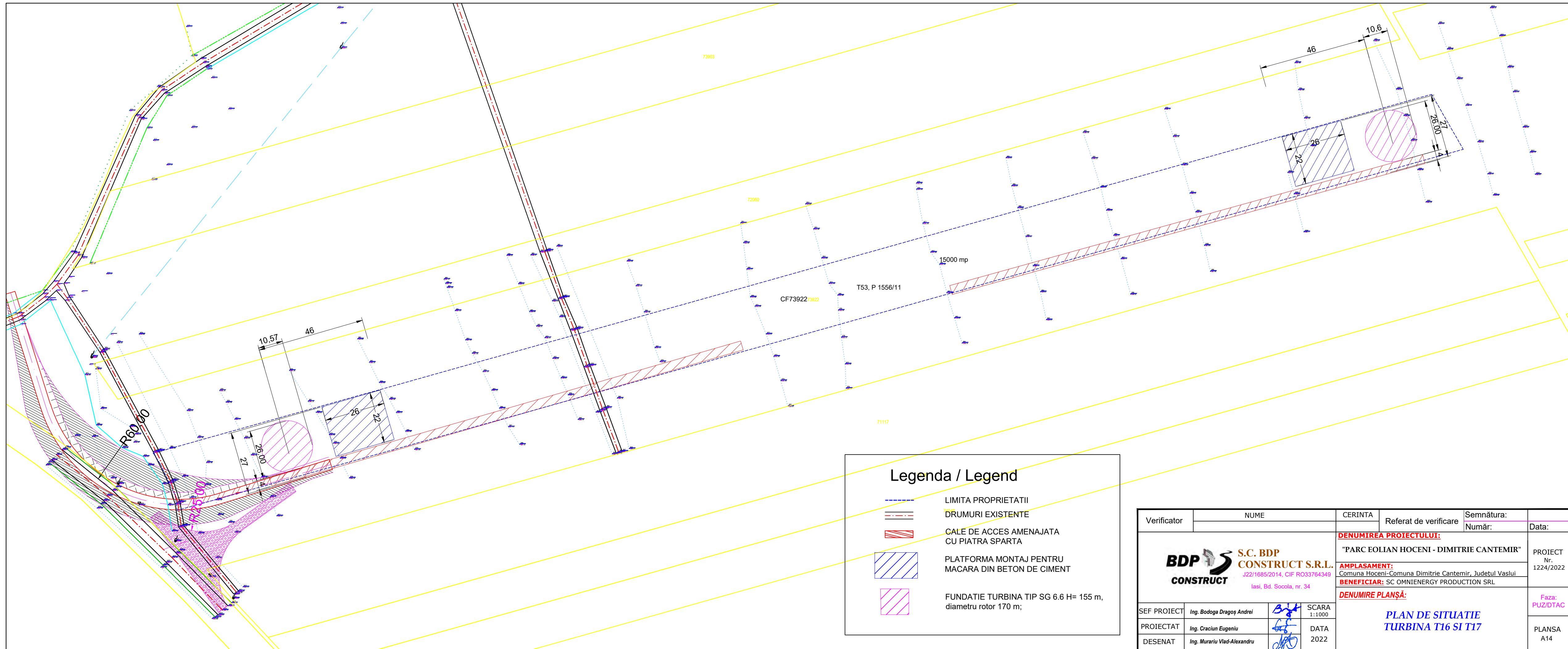



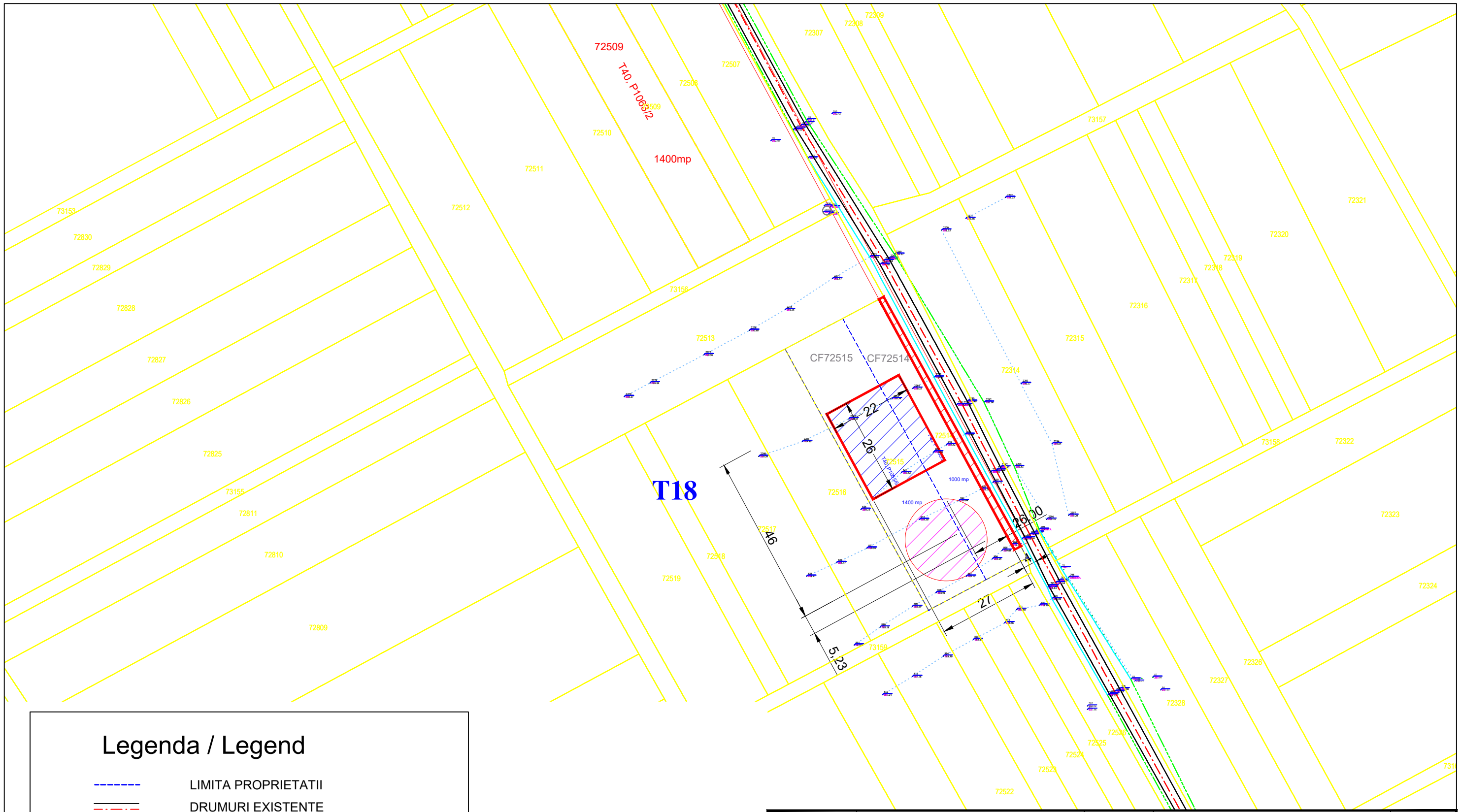

Legenda / Legend

	LIMITA PROPRIETATII
	DRUMURI EXISTENTE
	CALE DE ACCES AMENAJATA CU PIATRA SPARTA
	PLATFORMA MONTAJ PENTRU MACARA DIN BETON DE CIMENT
	FUNDATIE TURBINA TIP SG 6.6 H= 155 m, diametru rotor 170 m;

Verificator	NUME	CERINTA	Referat de verificare	Semnătura:	Data:
				Număr:	
S.C. BDP CONSTRUCT S.R.L. J22/1685/2014, CIF RO33764349 Iasi, Bd. Socola, nr. 34		DENUMIREA PROIECTULUI:			PROIECT Nr. 1224/2022
		"PARC EOLIAN HOCENI - DIMITRIE CANTEMIR"			
		AMPLASAMENT: Comuna Hocenii-Comuna Dimitrie Cantemir, Judetul Vaslui			
		BENEFICIAR: SC OMNIENERGY PRODUCTION SRL			Faza: PUZ/DTAC
		DENUMIRE PLANȘĂ:			
		PLAN DE SITUATIE TURBINA T16 SI T17			
SEF PROIECT	Ing. Bodoga Dragoș Andrei		SCARA 1:1000		
PROIECTAT	Ing. Craciun Eugeniu		DATA 2022		
DESENAT	Ing. Murariu Vlad-Alexandru			PLANSA A14	



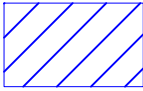



Legenda / Legend

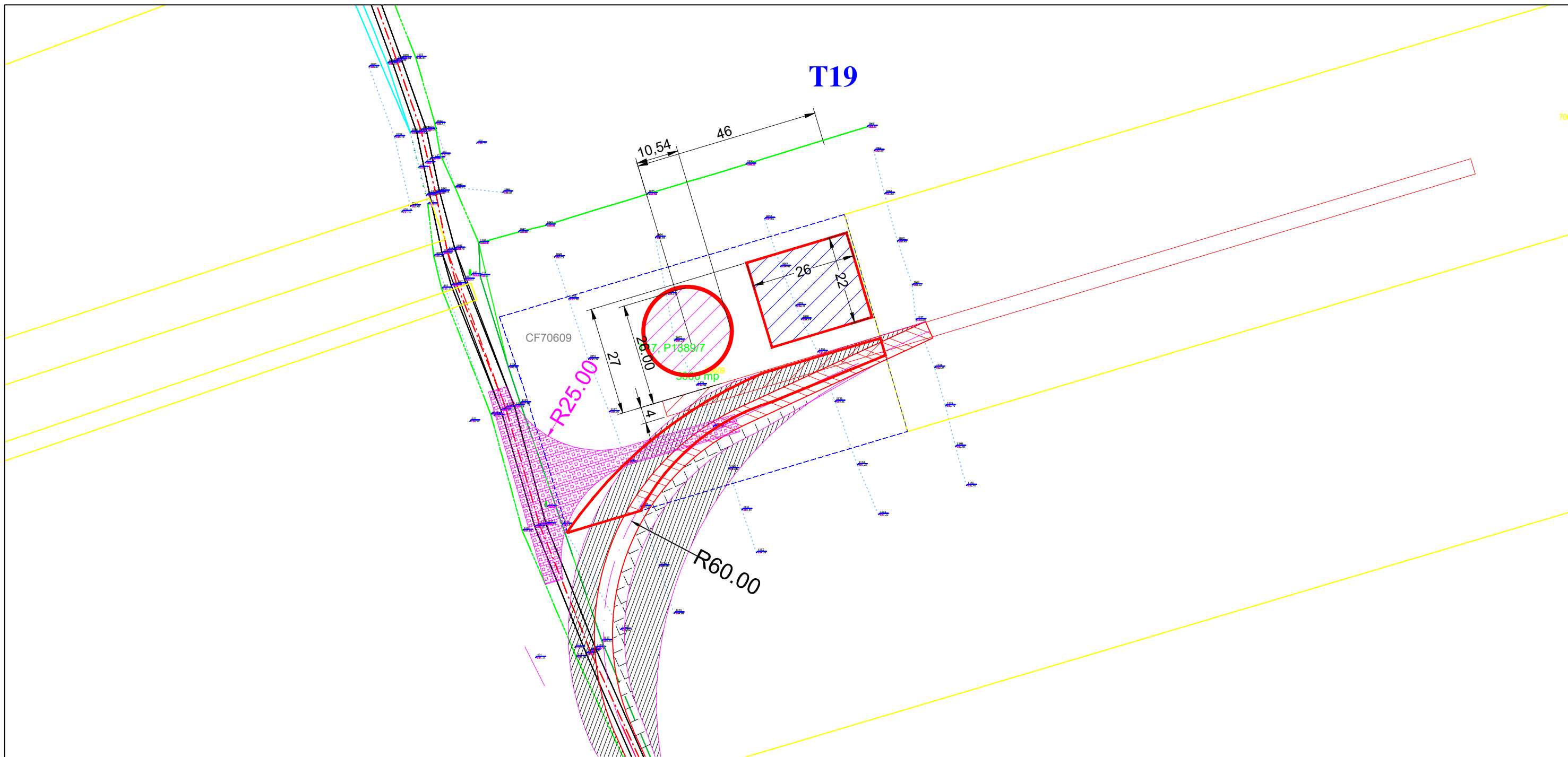

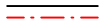

-  LIMITA PROPRIETATII
-  DRUMURI EXISTENTE
-  CALE DE ACCES AMENAJATA CU PIATRA SPARTA
-  PLATFORMA MONTAJ PENTRU MACARA DIN BETON DE CIMENT
-  FUNDATIE TURBINA TIP SG 6.6 H= 155 m, diametru rotor 170 m;

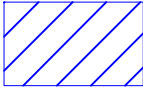
Verificator	NUME	CERINTA	Referat de verificare	Semnătura: Număr:	Data:
 S.C. BDP CONSTRUCT S.R.L. J22/1685/2014, CIF RO33764349 Iasi, Bd. Socola, nr. 34		DENUMIREA PROIECTULUI: "PARC EOLIAN HOCENI - DIMITRIE CANTEMIR"			PROIECT Nr. 1224/2022 Faza: PUZ/DTAC
		AMPLASAMENT: Comuna Hoceni-Comuna Dimitrie Cantemir, Judetul Vaslui BENEFICIAR: SC OMNIENERGY PRODUCTION SRL			
SEF PROIECT	Ing. Bodoș Dragoș Andrei		SCARA 1:1000	PLAN DE SITUATIE TURBINA T18	
PROIECTAT	Ing. Craciun Eugeniu		DATA 2022		
DESENAT	Ing. Murariu Vlad-Alexandru				



Legenda / Legend

-  LIMITA PROPRIETATII
-  DRUMURI EXISTENTE
-  CALE DE ACCES AMENAJATA CU PIATRA SPARTA
-  PLATFORMA MONTAJ PENTRU MACARA DIN BETON DE CIMENT
-  FUNDATIE TURBINA TIP SG 6.6 H= 155 m, diametru rotor 170 m;

Verificator	NUME	CERINTA	Referat de verificare	Semnătura: Număr:	Data:
 S.C. BDP CONSTRUCT S.R.L. J22/1685/2014, CIF RO33764349 Iasi, Bd. Socola, nr. 34		DENUMIREA PROIECTULUI:			PROIECT Nr. 1224/2022
		"PARC EOLIAN HOCENI - DIMITRIE CANTEMIR"			
		AMPLASAMENT: Comuna Hoceni-Comuna Dimitrie Cantemir, Judetul Vaslui			BENEFICIAR: SC OMNIENERGY PRODUCTION SRL
SEF PROIECT		Ing. Bodoș Dragos Andrei		SCARA 1:1000	PLAN DE SITUATIE TURBINA T19 Faza: PUZ/DTAC PLANSA A16
PROIECTAT		Ing. Craciun Eugeniu		DATA 2022	
DESENAT		Ing. Murariu Vlad-Alexandru			

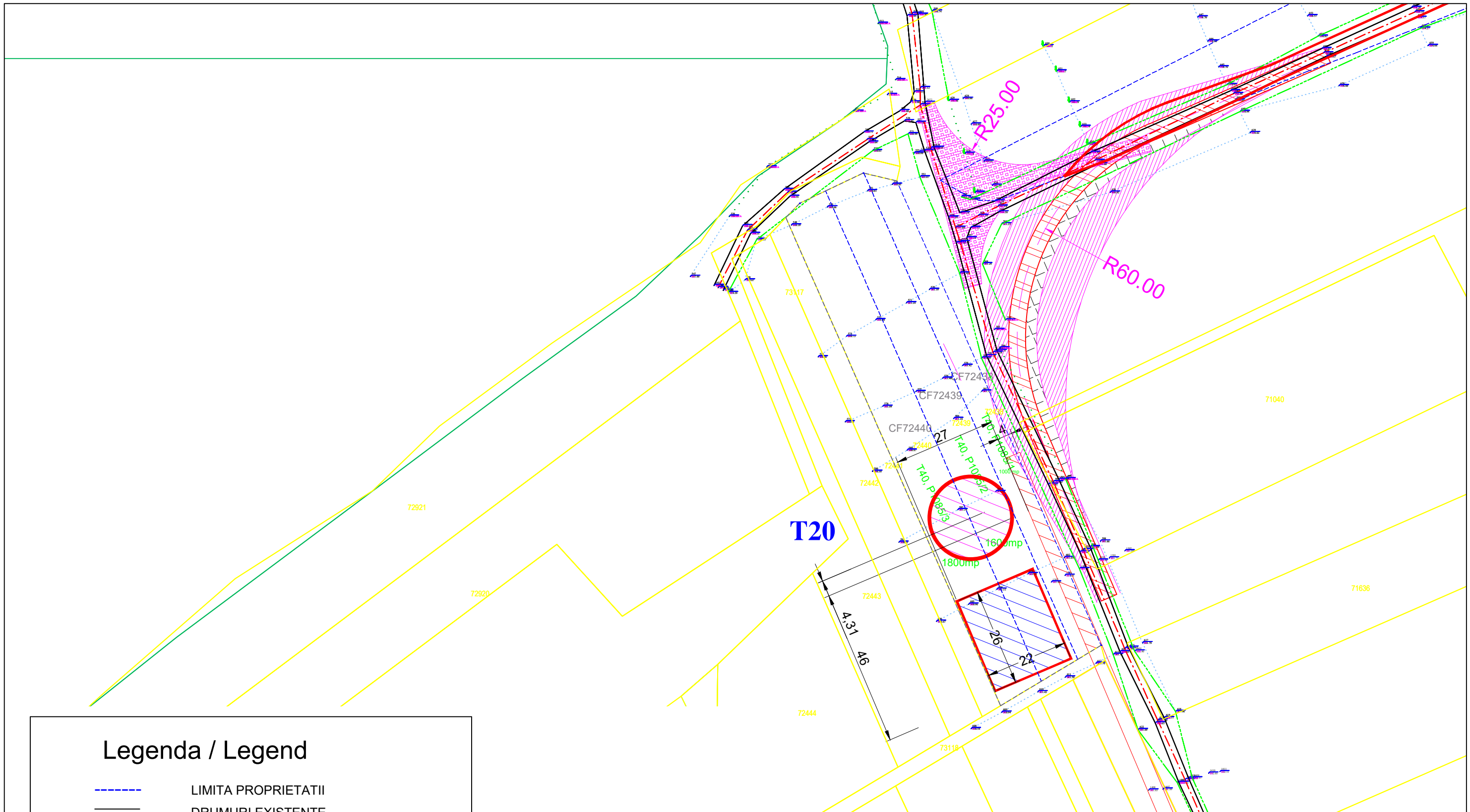

Legenda / Legend

- LIMITA PROPRIETATII
- DRUMURI EXISTENTE
- CALE DE ACCES AMENAJATA CU PIATRA SPARTA
- PLATFORMA MONTAJ PENTRU MACARA DIN BETON DE CIMENT
- FUNDATIE TURBINA TIP SG 6.6 H= 155 m, diametru rotor 170 m;

Verificator	NUME	CERINTA	Referat de verificare	Semnătura: Număr:	Data:
S.C. BDP CONSTRUCT S.R.L. <small>J22/1685/2014, CIF RO33764349 Iasi, Bd. Socola, nr. 34</small>		DENUMIREA PROIECTULUI:			PROIECT Nr. 1224/2022
		"PARC EOLIAN HOCENI - DIMITRIE CANTEMIR" AMPLASAMENT: Comuna Hoceni-Comuna Dimitrie Cantemir, Judetul Vaslui BENEFICIAR: SC OMNIENERGY PRODUCTION SRL			
SEF PROIECT		Ing. Bodoș Dragoș Andrei		SCARA 1:1000	PLAN DE SITUATIE TURBINA T20
PROIECTAT		Ing. Craciun Eugeniu		DATA 2022	
DESENAT		Ing. Murariu Vlad-Alexandru			
					Faza: PUZ/DTAC
					PLANSA A17

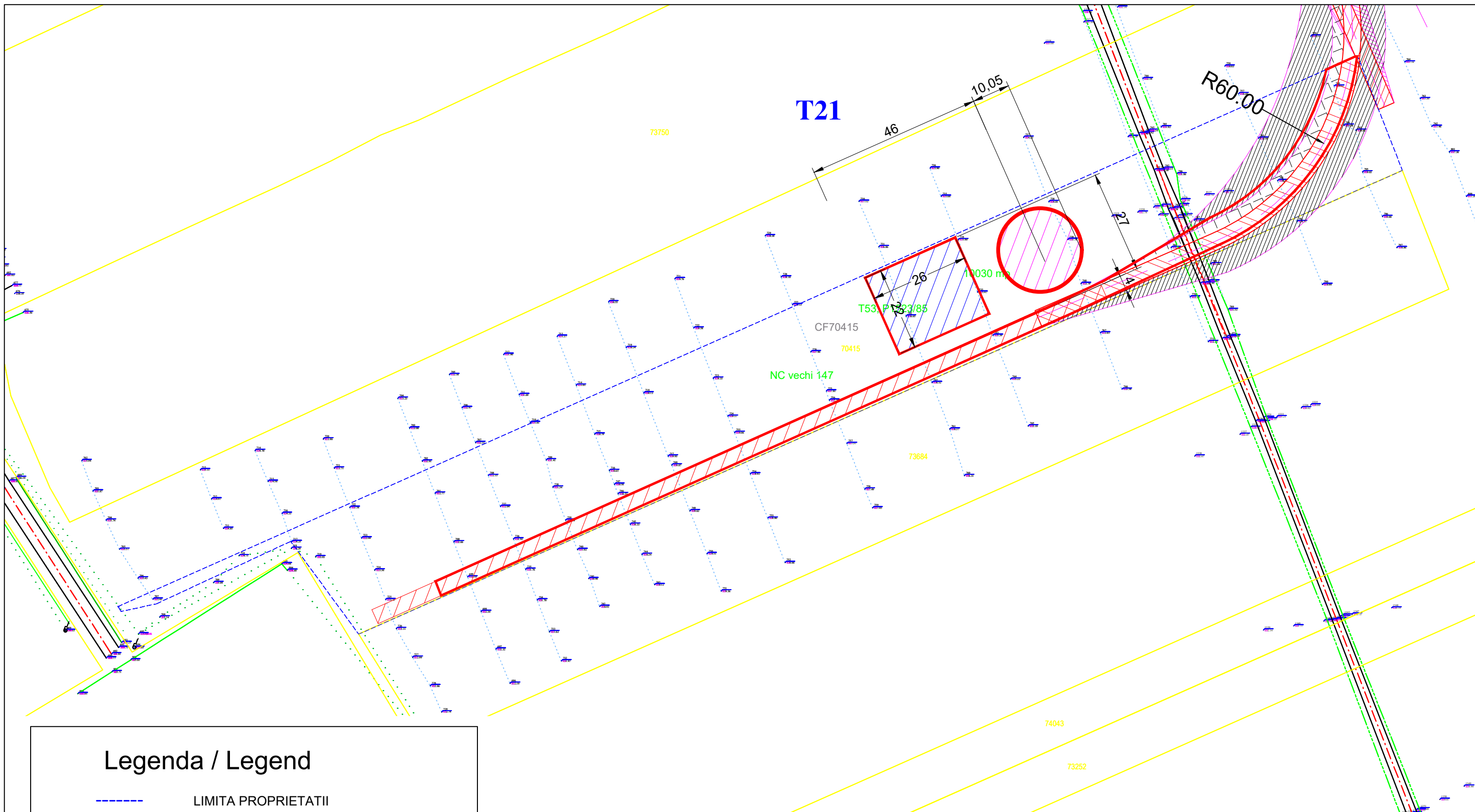





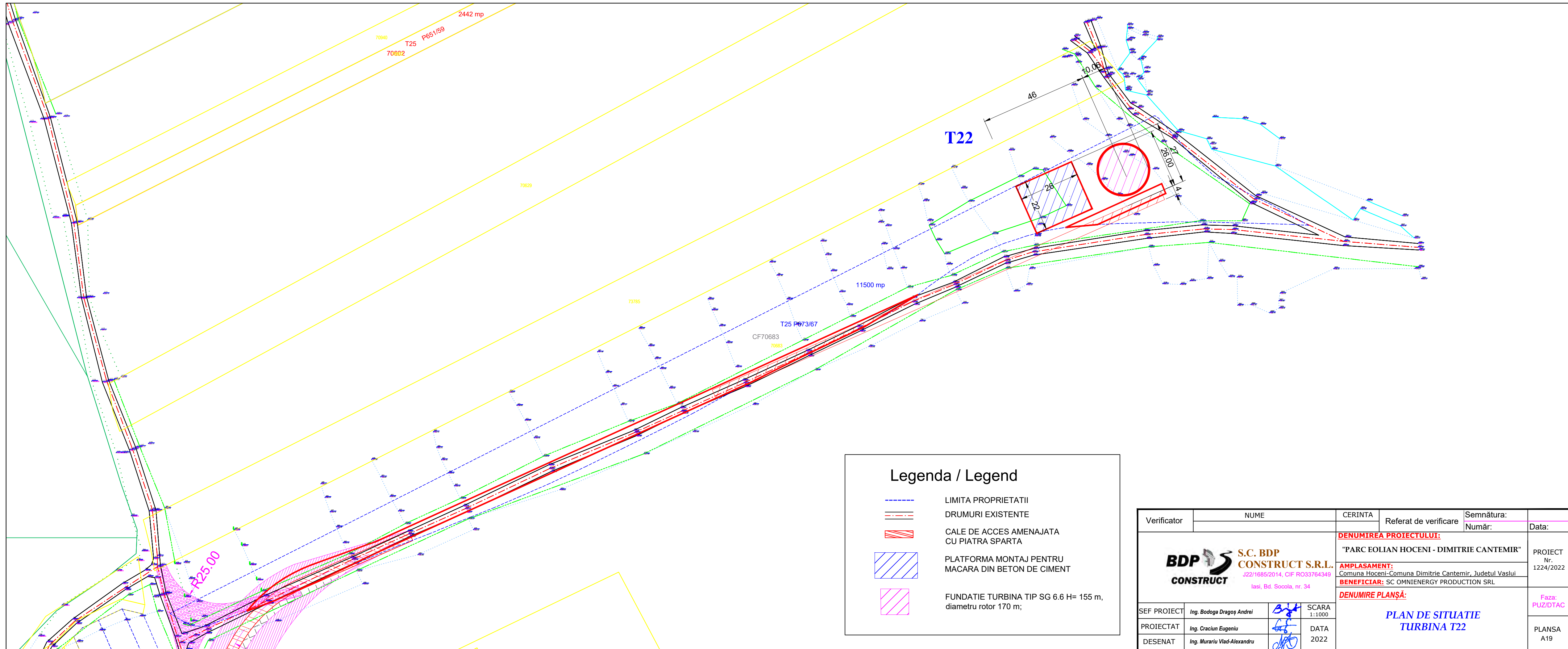

Legenda / Legend	
	LIMITA PROPRIETATII
	DRUMURI EXISTENTE
	CALE DE ACCES AMENAJATA CU PIATRA SPARTA
	PLATFORMA MONTAJ PENTRU MACARA DIN BETON DE CIMENT
	FUNDATIE TURBINA TIP SG 6.6 H= 155 m, diametru rotor 170 m;

Verificator	NUME	CERINTA	Referat de verificare	Semnătura: Număr:	Data:
S.C. BDP CONSTRUCT S.R.L. J22/1685/2014, CIF RO33764349 Iasi, Bd. Socola, nr. 34		DENUMIREA PROIECTULUI:			PROIECT Nr. 1224/2022
		"PARC EOLIAN HOCENI - DIMITRIE CANTEMIR" AMPLASAMENT: Comuna Hoceni-Comuna Dimitrie Cantemir, Judetul Vaslui BENEFICIAR: SC OMNIENERGY PRODUCTION SRL			
SEF PROIECT		Ing. Bodoș Dragoș Andrei		SCARA 1:1000	PLAN DE SITUATIE TURBINA T21 Faza: PUZ/DTAC PLANSA A18
PROIECTAT		Ing. Craciun Eugeniu		DATA 2022	
DESENAT		Ing. Murariu Vlad-Alexandru			

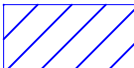
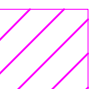





Legenda / Legend

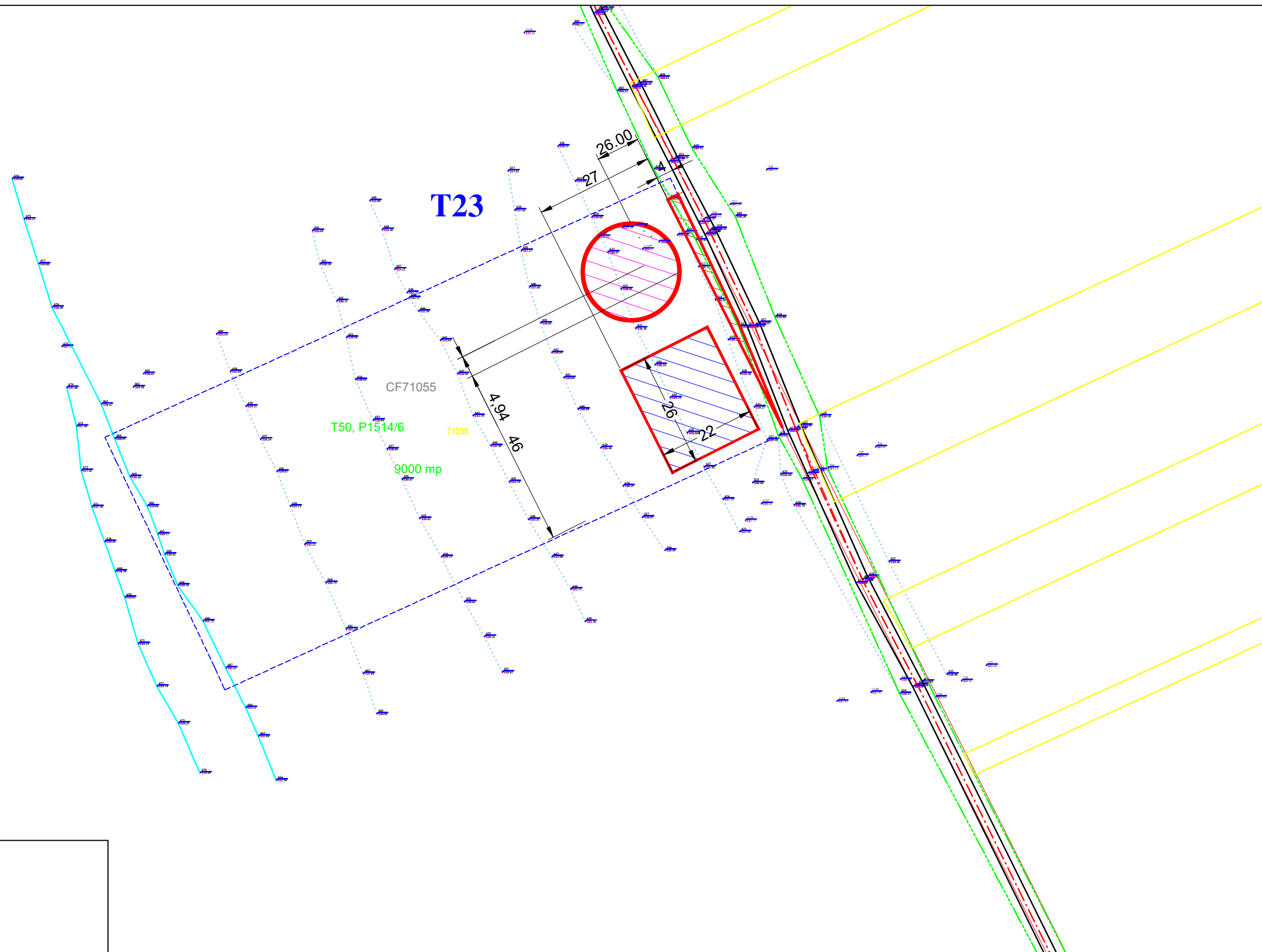

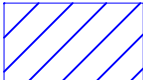

-  LIMITA PROPRIETATII
-  DRUMURI EXISTENTE
-  CALE DE ACCES AMENAJATA CU PIATRA SPARTA
-  PLATFORMA MONTAJ PENTRU MACARA DIN BETON DE CIMENT
-  FUNDATIE TURBINA TIP SG 6.6 H= 155 m, diametru rotor 170 m;

Verificator	NUME	CERINTA	Referat de verificare	Semnătura:	Data:
				Număr:	
 S.C. BDP CONSTRUCT S.R.L. <small>J22/1685/2014, CIF RO33764349 Iasi, Bd. Socola, nr. 34</small>		DENUMIREA PROIECTULUI:			PROIECT Nr. 1224/2022
		"PARC EOLIAN HOCENI - DIMITRIE CANTEMIR"			
		AMPLASAMENT: Comuna Hocenii-Comuna Dimitrie Cantemir, Judetul Vaslui BENEFICIAR: SC OMNIENERGY PRODUCTION SRL			
SEF PROIECT		Ing. Bodoga Dragoș Andrei		SCARA 1:1000	Faza: PUZ/DTAC
PROIECTAT		Ing. Craciun Eugeniu		DATA	
DESENAT		Ing. Murariu Vlad-Alexandru		2022	
PLAN DE SITUATIE TURBINA T22					PLANSA A19

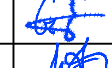

Legenda / Legend

-  LIMITA PROPRIETATII
-  DRUMURI EXISTENTE
-  CALE DE ACCES AMENAJATA CU PIATRA SPARTA
-  PLATFORMA MONTAJ PENTRU MACARA DIN BETON DE CIMENT
-  FUNDATIE TURBINA TIP SG 6.6 H= 155 m, diametru rotor 170 m;

Verificator	NUME	CERINTA	Referat de verificare	Semnătura: Număr:	Data:
 S.C. BDP CONSTRUCT S.R.L. J22/1685/2014, CIF RO33764349 Iasi, Bd. Socola, nr. 34		DENUMIREA PROIECTULUI: "PARC EOLIAN HOCENI - DIMITRIE CANTEMIR"			PROIECT Nr. 1224/2022 Faza: PUZ/DTAC
		AMPLASAMENT: Comuna Hoceni-Comuna Dimitrie Cantemir, Judetul Vaslui BENEFICIAR: SC OMNIENERGY PRODUCTION SRL			
SEF PROIECT	Ing. Bodoș Dragoș Andrei		SCARA 1:1000	PLAN DE SITUATIE TURBINA T23	
PROIECTAT	Ing. Craciun Eugeniu		DATA 2022		
DESENAT	Ing. Murariu Vlad-Alexandru				

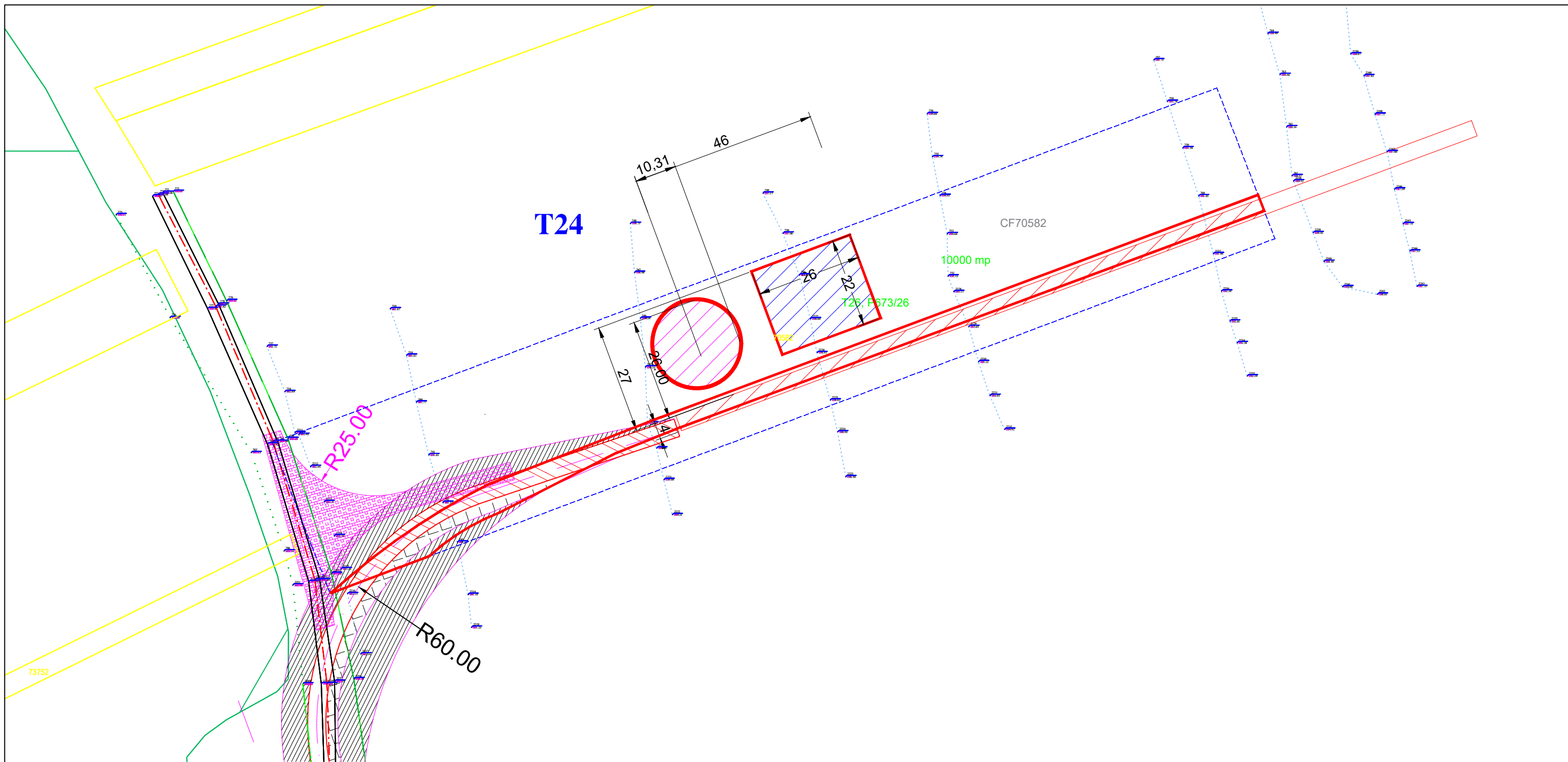

Legenda / Legend

- LIMITA PROPRIETATII
- DRUMURI EXISTENTE
- CALE DE ACCES AMENAJATA CU PIATRA SPARTA
- PLATFORMA MONTAJ PENTRU MACARA DIN BETON DE CIMENT
- FUNDATIE TURBINA TIP SG 6.6 H= 155 m, diametru rotor 170 m;





Verificator	NUME	CERINTA	Referat de verificare	Semnătura: Număr:	Data:
S.C. BDP CONSTRUCT S.R.L. <small>J22/1685/2014, CIF RO33764349 Iasi, Bd. Socola, nr. 34</small>			DENUMIREA PROIECTULUI:		PROIECT Nr. 1224/2022
			"PARC EOLIAN HOCENI - DIMITRIE CANTEMIR"		
			AMPLASAMENT:		Faza: PUZ/DTAC
			Comuna Hoceni-Comuna Dimitrie Cantemir, Judetul Vaslui		
			BENEFICIAR: SC OMNIENERGY PRODUCTION SRL		PLANSA A21
			DENUMIRE PLANȘĂ:		
PLAN DE SITUATIE TURBINA T24					
SEF PROIECT	Ing. Bodoș Dragoș Andrei		SCARA 1:1000		
PROIECTAT	Ing. Craciun Eugeniu		DATA 2022		
DESENAT	Ing. Murariu Vlad-Alexandru				

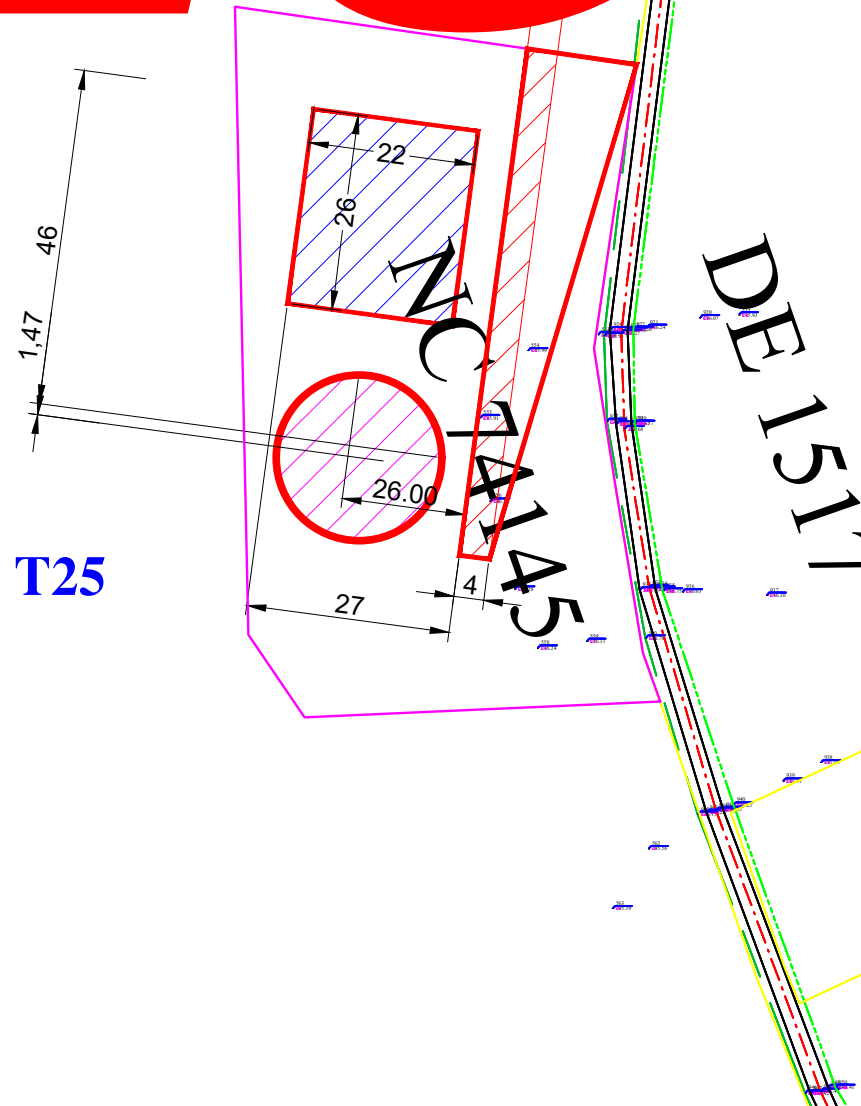

125

72110

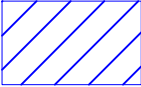





Legenda / Legend





-  LIMITA PROPRIETATII
-  DRUMURI EXISTENTE
-  CALE DE ACCES AMENAJATA CU PIATRA SPARTA
-  PLATFORMA MONTAJ PENTRU MACARA DIN BETON DE CIMENT
-  FUNDATIE TURBINA TIP SG 6.6 H= 155 m, diametru rotor 170 m;

Verificator	NUME	CERINTA	Referat de verificare	Semnătura: Număr:	Data:
 S.C. BDP CONSTRUCT S.R.L. J22/1685/2014, CIF RO33764349 Iasi, Bd. Socola, nr. 34		DENUMIREA PROIECTULUI:			PROIECT Nr. 1224/2022
		"PARC EOLIAN HOCENI - DIMITRIE CANTEMIR" AMPLASAMENT: Comuna Hoceni-Comuna Dimitrie Cantemir, Judetul Vaslui BENEFICIAR: SC OMNIENERGY PRODUCTION SRL			
SEF PROIECT	Ing. Bodoș Dragoș Andrei		SCARA 1:1000	PLAN DE SITUATIE TURBINA T25	
PROIECTAT	Ing. Craciun Eugeniu		DATA 2022		
DESENAT	Ing. Murariu Vlad-Alexandru				
					Faza: PUZ/DTAC
					PLANSA A22

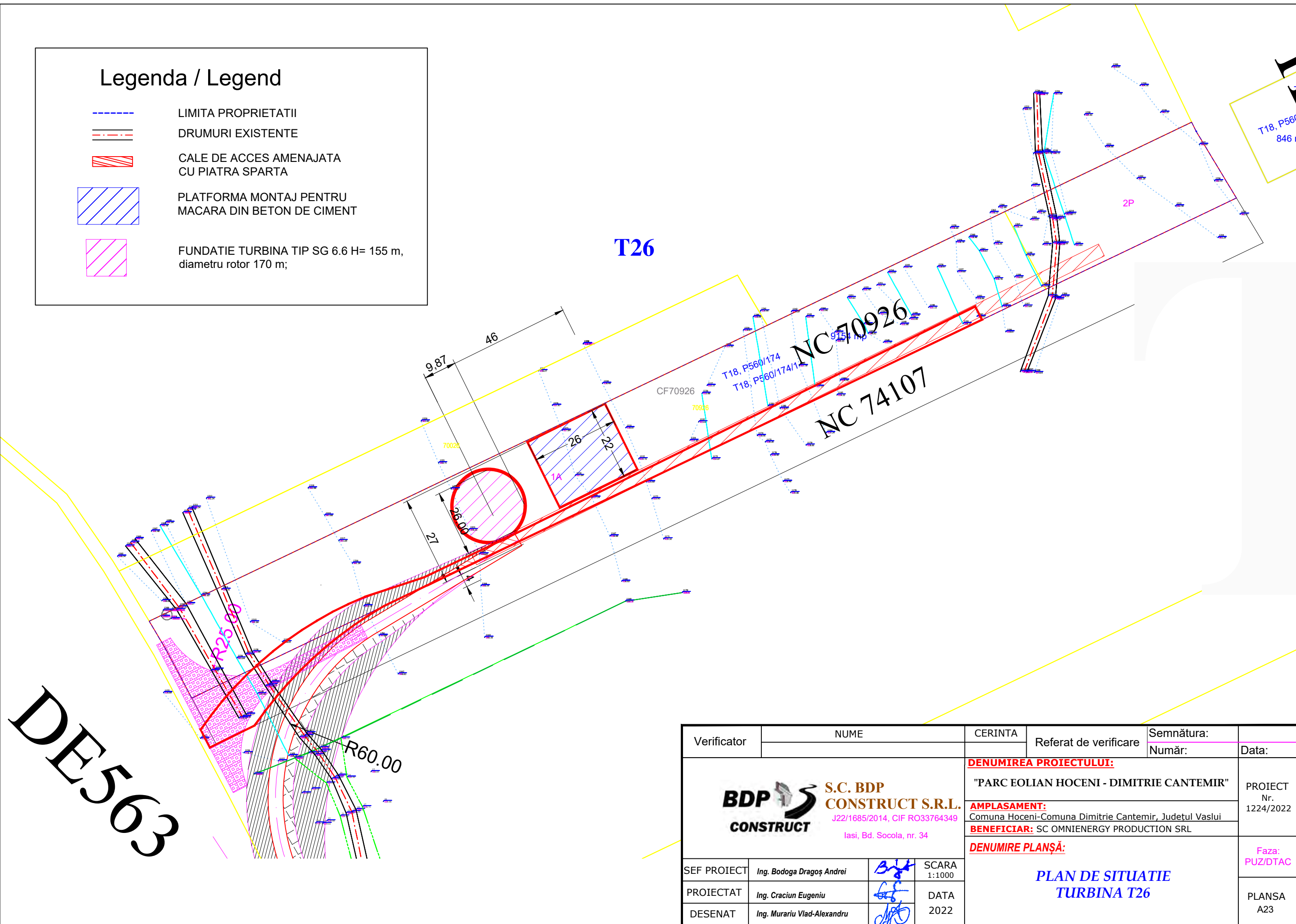

Legenda / Legend

-  LIMITA PROPRIETATII
-  DRUMURI EXISTENTE
-  CALE DE ACCES AMENAJATA CU PIATRA SPARTA
-  PLATFORMA MONTAJ PENTRU MACARA DIN BETON DE CIMENT
-  FUNDATIE TURBINA TIP SG 6.6 H= 155 m, diametru rotor 170 m;





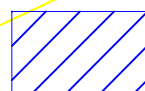
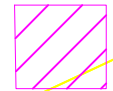

Verificator	NUME		CERINTA	Referat de verificare	Semnătura: Număr:	Data:	
	 S.C. BDP CONSTRUCT S.R.L. J22/1685/2014, CIF R033764349 Iasi, Bd. Socola, nr. 34		DENUMIREA PROIECTULUI: "PARC EOLIAN HOCENI - DIMITRIE CANTEMIR"		PROIECT Nr. 1224/2022		
SEF PROIECT		Ing. Bodoaga Dragoş Andrei		SCARA 1:1000	DENUMIRE PLANŞĂ: PLAN DE SITUATIE TURBINA T26		
PROIECTAT		Ing. Craciun Eugeniu		DATA 2022			Faza: PUZ/DTAC
DESENAT		Ing. Murariu Vlad-Alexandru					PLANSA A23

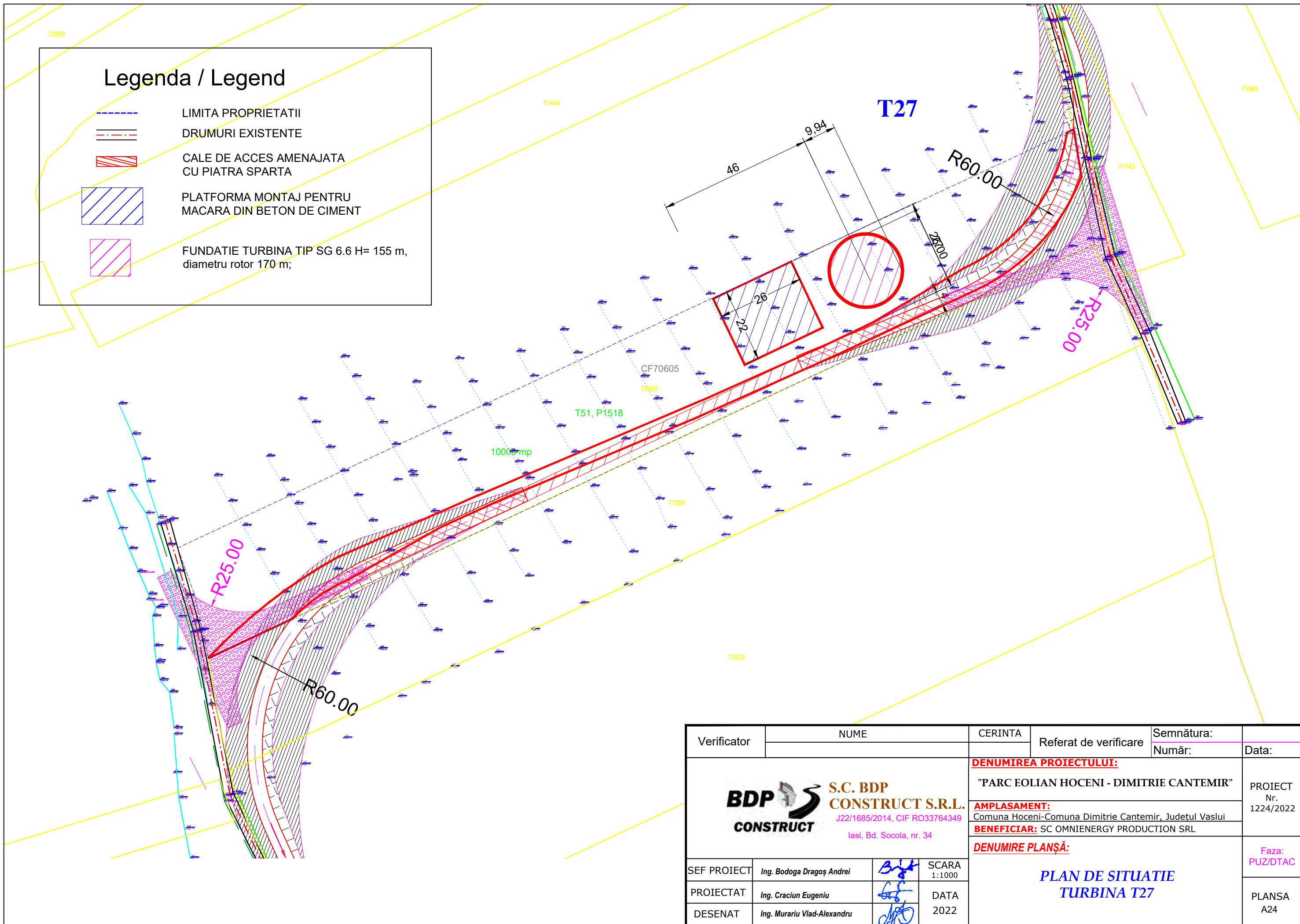
Legenda / Legend

-  LIMITA PROPRIETATII
-  DRUMURI EXISTENTE
-  CALE DE ACCES AMENAJATA CU PIATRA SPARTA
-  PLATFORMA MONTAJ PENTRU MACARA DIN BETON DE CIMENT
-  FUNDATIE TURBINA TIP SG 6.6 H= 155 m, diametru rotor 170 m;





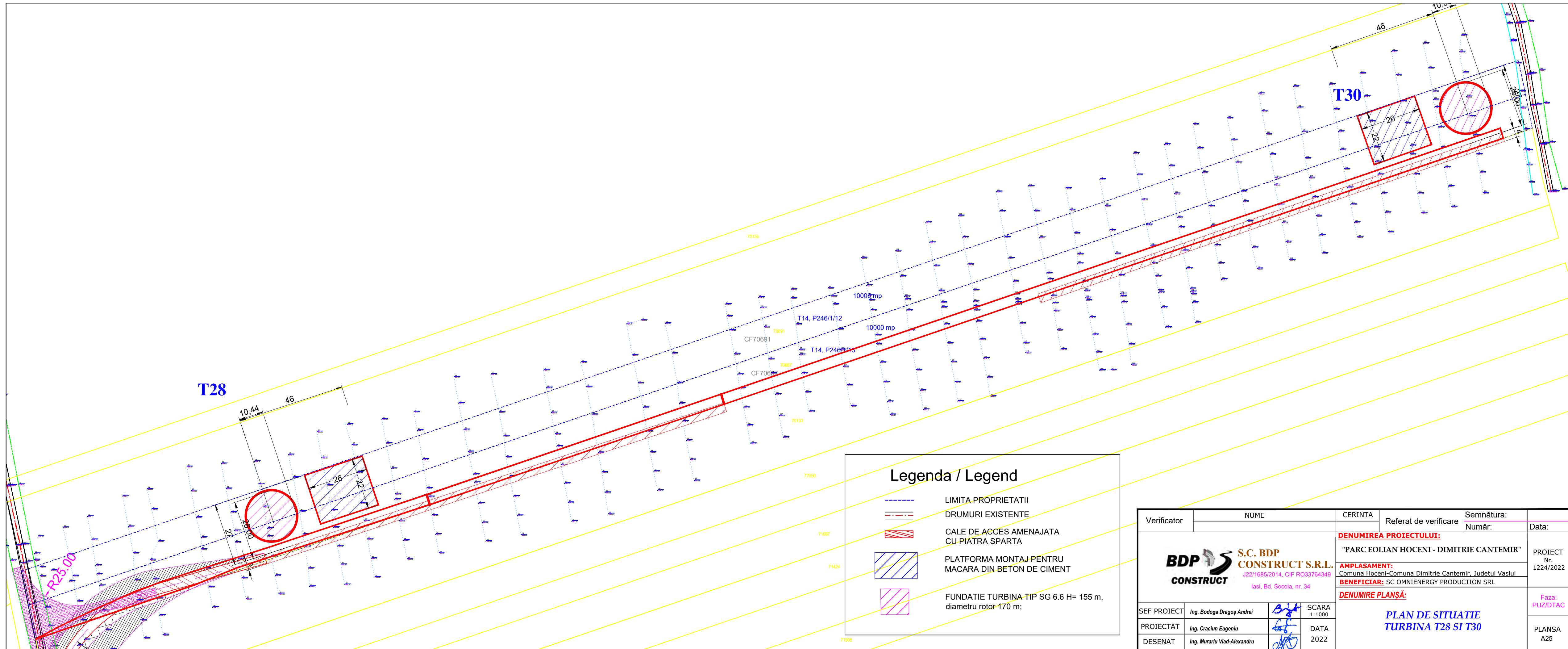

Verificator	NUME	CERINTA	Referat de verificare	Semnătura:	Data:
				Număr:	
 S.C. BDP CONSTRUCT S.R.L. J22/1685/2014, CIF RO33764349 Iasi, Bd. Socola, nr. 34			DENUMIREA PROIECTULUI: "PARC EOLIAN HOCENI - DIMITRIE CANTEMIR"		PROIECT Nr. 1224/2022
			AMPLASAMENT: Comuna Hoceni-Comuna Dimitrie Cantemir, Judetul Vaslui BENEFICIAR: SC OMNIENERGY PRODUCTION SRL		
SEF PROIECT <i>Ing. Bodega Dragoş Andrei</i>  SCARA 1:1000			DENUMIRE PLANŞĂ: PLAN DE SITUATIE TURBINA T27		Faza: PUZ/DTAC PLANSA A24
PROIECTAT <i>Ing. Craciun Eugeniu</i>  DATA 2022					
DESENAT <i>Ing. Murariu Vlad-Alexandru</i> 					







Legenda / Legend	
	LIMITA PROPRIETATII
	DRUMURI EXISTENTE
	CALE DE ACCES AMENAJATA CU PIATRA SPARTA
	PLATFORMA MONTAJ PENTRU MACARA DIN BETON DE CIMENT
	FUNDATIE TURBINA TIP SG 6.6 H= 155 m, diametru rotor 170 m;

Verificator	NUME	CERINTA	Referat de verificare	Semnătura:	Data:
				Număr:	
S.C. BDP CONSTRUCT S.R.L. J22/1685/2014, CIF RO33764349 Iasi, Bd. Socola, nr. 34		DENUMIREA PROIECTULUI:			PROIECT Nr. 1224/2022
		"PARC EOLIAN HOCENI - DIMITRIE CANTEMIR"			
		AMPLASAMENT: Comuna Hocenii-Comuna Dimitrie Cantemir, Judetul Vaslui			
		BENEFICIAR: SC OMNIENERGY PRODUCTION SRL			Faza: PUZ/DTAC
		DENUMIRE PLANȘĂ:			
		PLAN DE SITUATIE TURBINA T28 SI T30			
SEF PROIECT	Ing. Bodoga Dragoș Andrei		SCARA 1:1000		
PROIECTAT	Ing. Craciun Eugeniu		DATA 2022		
DESENAT	Ing. Murariu Vlad-Alexandru			PLANSA A25	

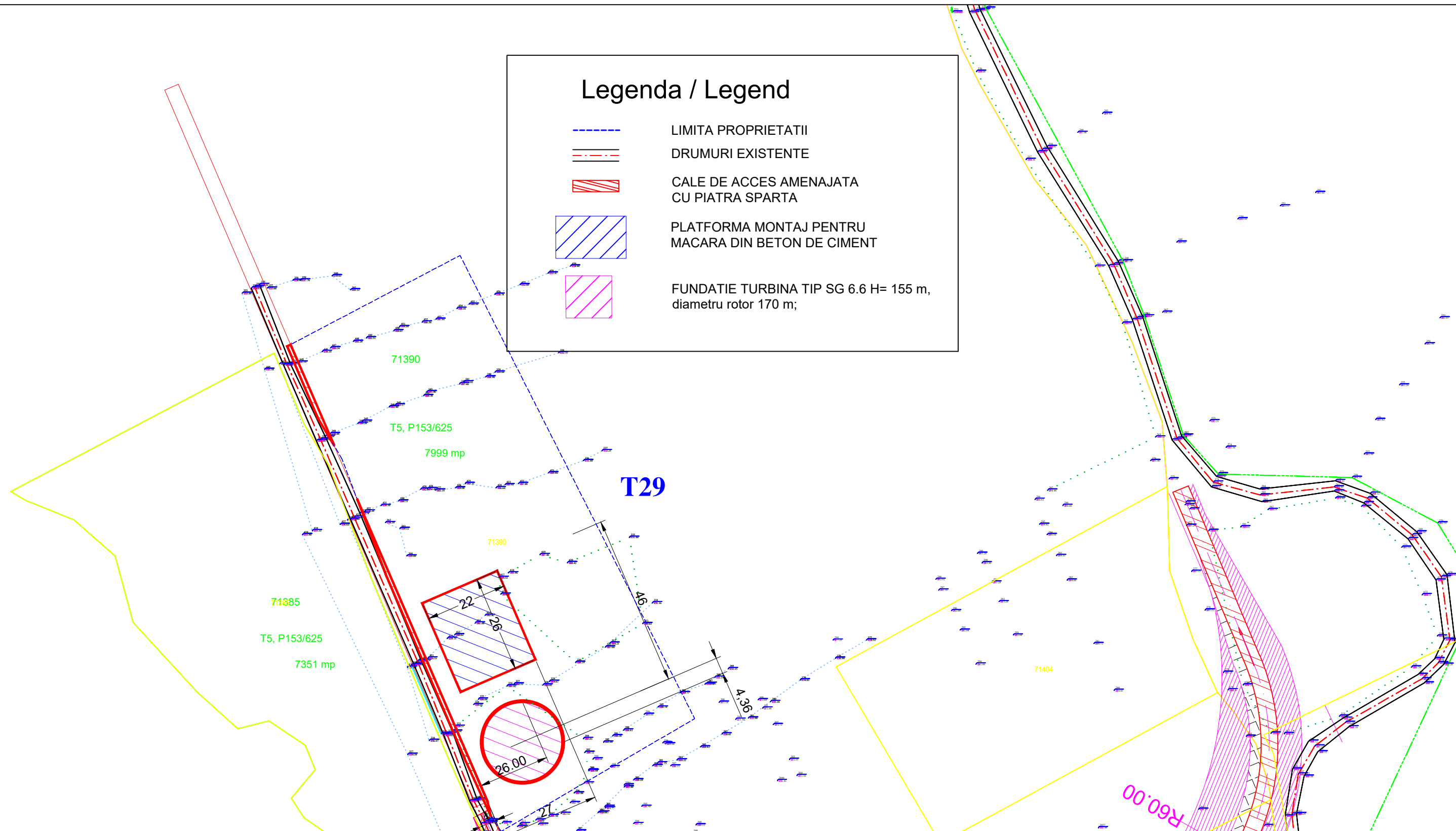



Legenda / Legend

-  LIMITA PROPRIETATII
-  DRUMURI EXISTENTE
-  CALE DE ACCES AMENAJATA CU PIATRA SPARTA
-  PLATFORMA MONTAJ PENTRU MACARA DIN BETON DE CIMENT
-  FUNDATIE TURBINA TIP SG 6.6 H= 155 m, diametru rotor 170 m;



Verificator	NUME	CERINTA	Referat de verificare	Semnătura: Număr:	Data:
 S.C. BDP CONSTRUCT S.R.L. J22/1685/2014, CIF RO33764349 Iasi, Bd. Socola, nr. 34		DENUMIREA PROIECTULUI: "PARC EOLIAN HOCENI - DIMITRIE CANTEMIR"			PROIECT Nr. 1224/2022
		AMPLASAMENT: Comuna Hoceni-Comuna Dimitrie Cantemir, Judetul Vaslui BENEFICIAR: SC OMNIENERGY PRODUCTION SRL			
SEF PROIECT	Ing. Bodoaga Dragoş Andrei		SCARA 1:1000	PLAN DE SITUATIE TURBINA T29	
PROIECTAT	Ing. Craciun Eugeniu		DATA 2022		
DESENAT	Ing. Murariu Vlad-Alexandru				
				Faza: PUZ/DTAC	PLANSA A26

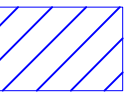

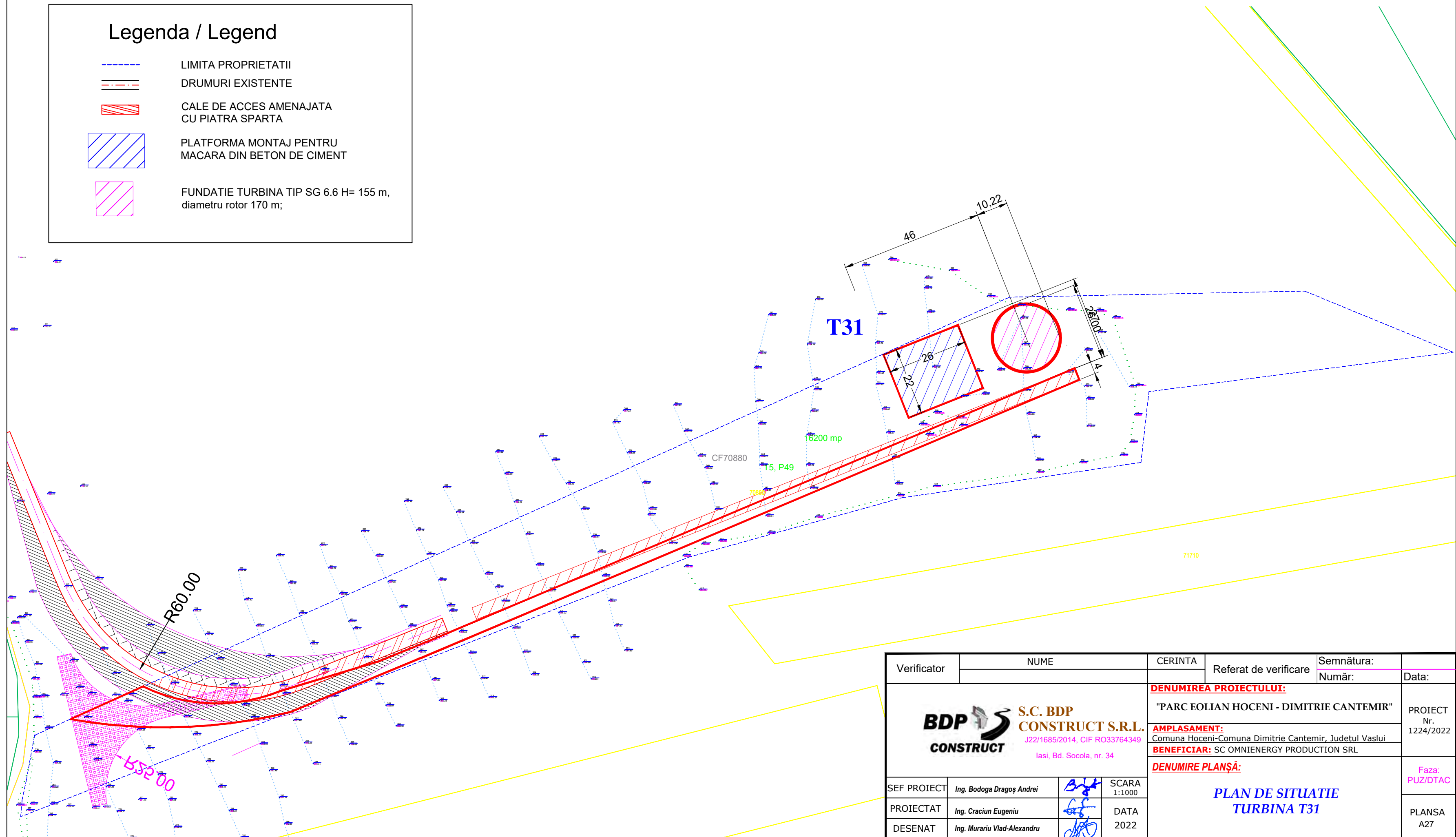

Legenda / Legend

-  LIMITA PROPRIETATII
-  DRUMURI EXISTENTE
-  CALE DE ACCES AMENAJATA CU PIATRA SPARTA
-  PLATFORMA MONTAJ PENTRU MACARA DIN BETON DE CIMENT
-  FUNDATIE TURBINA TIP SG 6.6 H= 155 m, diametru rotor 170 m;





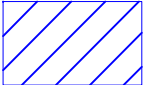

Verificator	NUME	CERINTA	Referat de verificare	Semnătura:	
				Număr:	Data:
 S.C. BDP CONSTRUCT S.R.L. J22/1685/2014, CIF R033764349 Iasi, Bd. Socola, nr. 34			DENUMIREA PROIECTULUI:		PROIECT Nr. 1224/2022
			"PARC EOLIAN HOCENI - DIMITRIE CANTEMIR"		
			AMPLASAMENT:		Faza: PUZIDTAC
			Comuna Hoceni-Comuna Dimitrie Cantemir, Judetul Vaslui		
			BENEFICIAR: SC OMNIENERGY PRODUCTION SRL		PLANSĂ A27
			DENUMIRE PLANȘĂ:		
			PLAN DE SITUATIE TURBINA T31		
			SEF PROIECT	Ing. Bodoga Dragoș Andrei	SCARA 1:1000
			PROIECTAT	Ing. Craciun Eugeniu	DATA 2022
DESENAT	Ing. Murariu Vlad-Alexandru				

Legenda / Legend

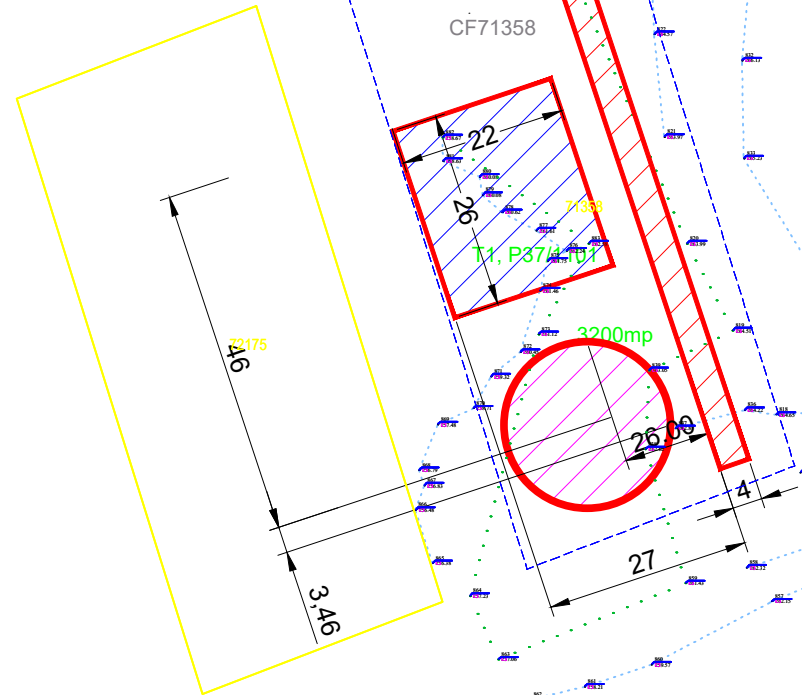



-  LIMITA PROPRIETATII
-  DRUMURI EXISTENTE
-  CALE DE ACCES AMENAJATA CU PIATRA SPARTA
-  PLATFORMA MONTAJ PENTRU MACARA DIN BETON DE CIMENT
-  FUNDATIE TURBINA TIP SG 6.6 H= 155 m, diametru rotor 170 m;

T32







Verificator	NUME	CERINTA	Referat de verificare	Semnătura: Număr:	Data:
 S.C. BDP CONSTRUCT S.R.L. J22/1685/2014, CIF RO33764349 Iasi, Bd. Socola, nr. 34		DENUMIREA PROIECTULUI: "PARC EOLIAN HOCENI - DIMITRIE CANTEMIR"			PROIECT Nr. 1224/2022
		AMPLASAMENT: Comuna Hoceni-Comuna Dimitrie Cantemir, Judetul Vaslui			
		BENEFICIAR: SC OMNIENERGY PRODUCTION SRL			
DENUMIRE PLANȘĂ: PLAN DE SITUATIE TURBINA T32		Faza: PUZ/DTAC			PLANSA A28
SEF PROIECT	Ing. Bodoș Dragoș Andrei		SCARA 1:1000		
PROIECTAT	Ing. Craciun Eugeniu		DATA 2022		
DESENAT	Ing. Murariu Vlad-Alexandru				

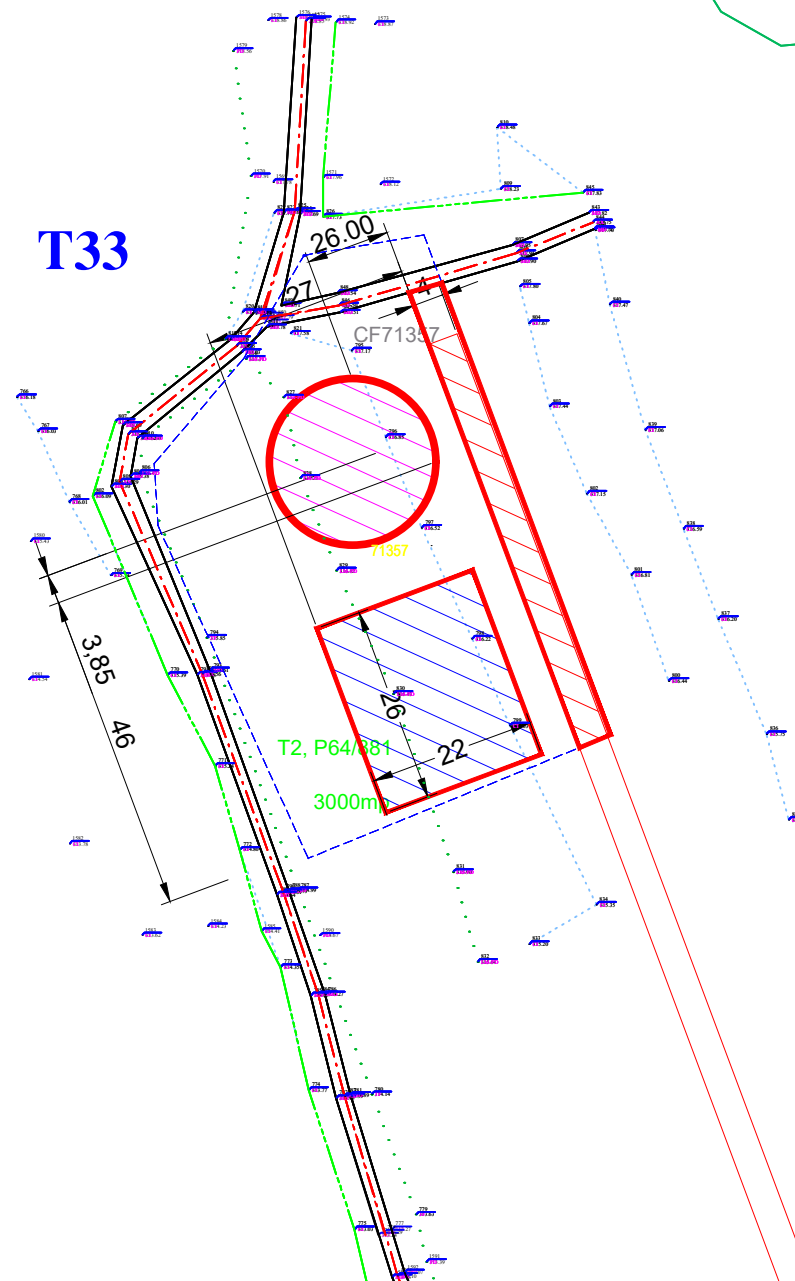



Legenda / Legend

-  LIMITA PROPRIETATII
-  DRUMURI EXISTENTE
-  CALE DE ACCES AMENAJATA CU PIATRA SPARTA
-  PLATFORMA MONTAJ PENTRU MACARA DIN BETON DE CIMENT
-  FUNDATIE TURBINA TIP SG 6.6 H= 155 m, diametru rotor 170 m;

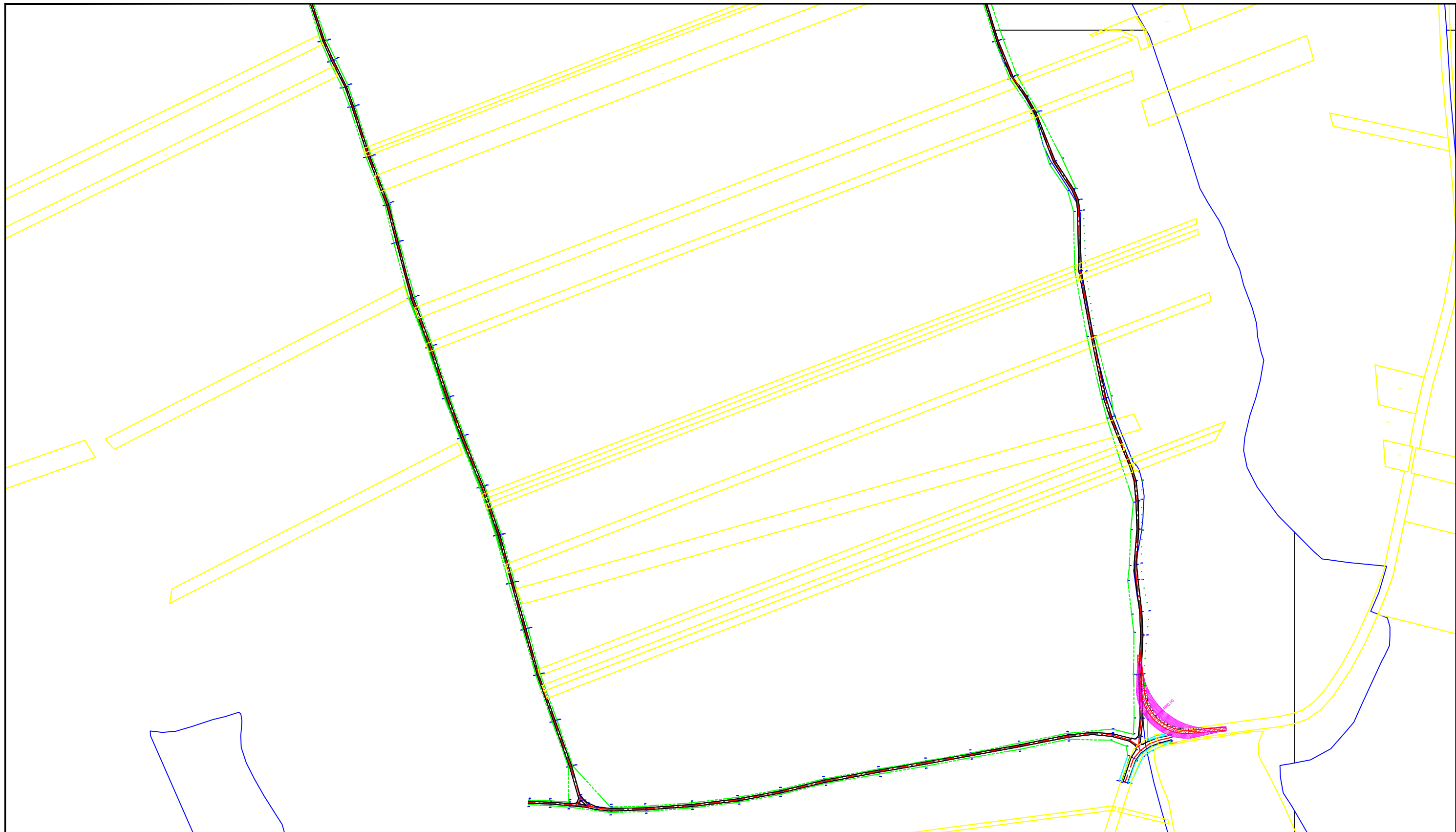





Verificator	NUME		CERINTA	Referat de verificare	Semnătura:	Data:
					Număr:	
 S.C. BDP CONSTRUCT S.R.L. J22/1685/2014, CIF RO33764349 Iasi, Bd. Socola, nr. 34			DENUMIREA PROIECTULUI: "PARC EOLIAN HOCENI - DIMITRIE CANTEMIR"		PROIECT Nr. 1224/2022	
			AMPLASAMENT: Comuna Hoceni-Comuna Dimitrie Cantemir, Judetul Vaslui BENEFICIAR: SC OMNIENERGY PRODUCTION SRL			
SEF PROIECT Ing. Bodoș Dragoș Andrei  SCARA 1:1000			DENUMIRE PLANȘĂ: PLAN DE SITUATIE TURBINA T33		Faza: PUZ/DTAC PLANSA A29	
PROIECTAT Ing. Craciun Eugeniu  DATA 2022						
DESENAT Ing. Murariu Vlad-Alexandru 						

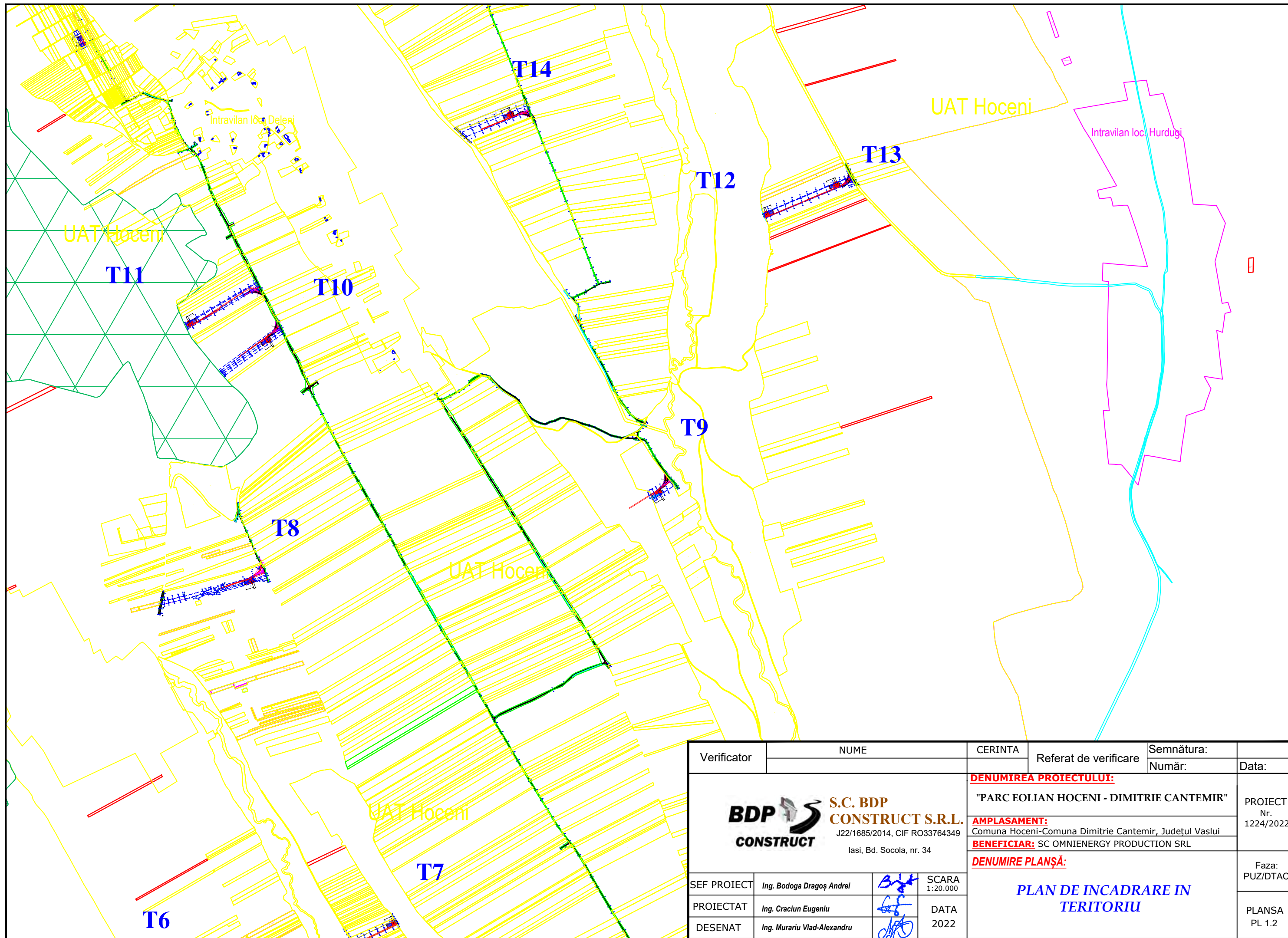





Verificator	NUME	CERINTA	Referat de verificare	Semnătura: Număr:	Data:	
 S.C. BDP CONSTRUCT S.R.L. J22/1685/2014, CIF RO33764349 Iasi, Bd. Socola, nr. 34		DENUMIREA PROIECTULUI: "PARC EOLIAN HOCENI - DIMITRIE CANTEMIR"			PROIECT Nr. 1224/2022	
		AMPLASAMENT: Comuna Hoceni-Comuna Dimitrie Cantemir, Judetul Vaslui BENEFICIAR: SC OMNIENERGY PRODUCTION SRL				
SEF PROIECT	Ing. Bodoaga Dragoş Andrei		SCARA 1:20.000	PLAN DE INCADRARE IN TERITORIU		
PROIECTAT	Ing. Craciun Eugeniu		DATA 2022			Faza: PUZ/DTAC
DESENAT	Ing. Murariu Vlad-Alexandru					PLANSĂ PL 1.1

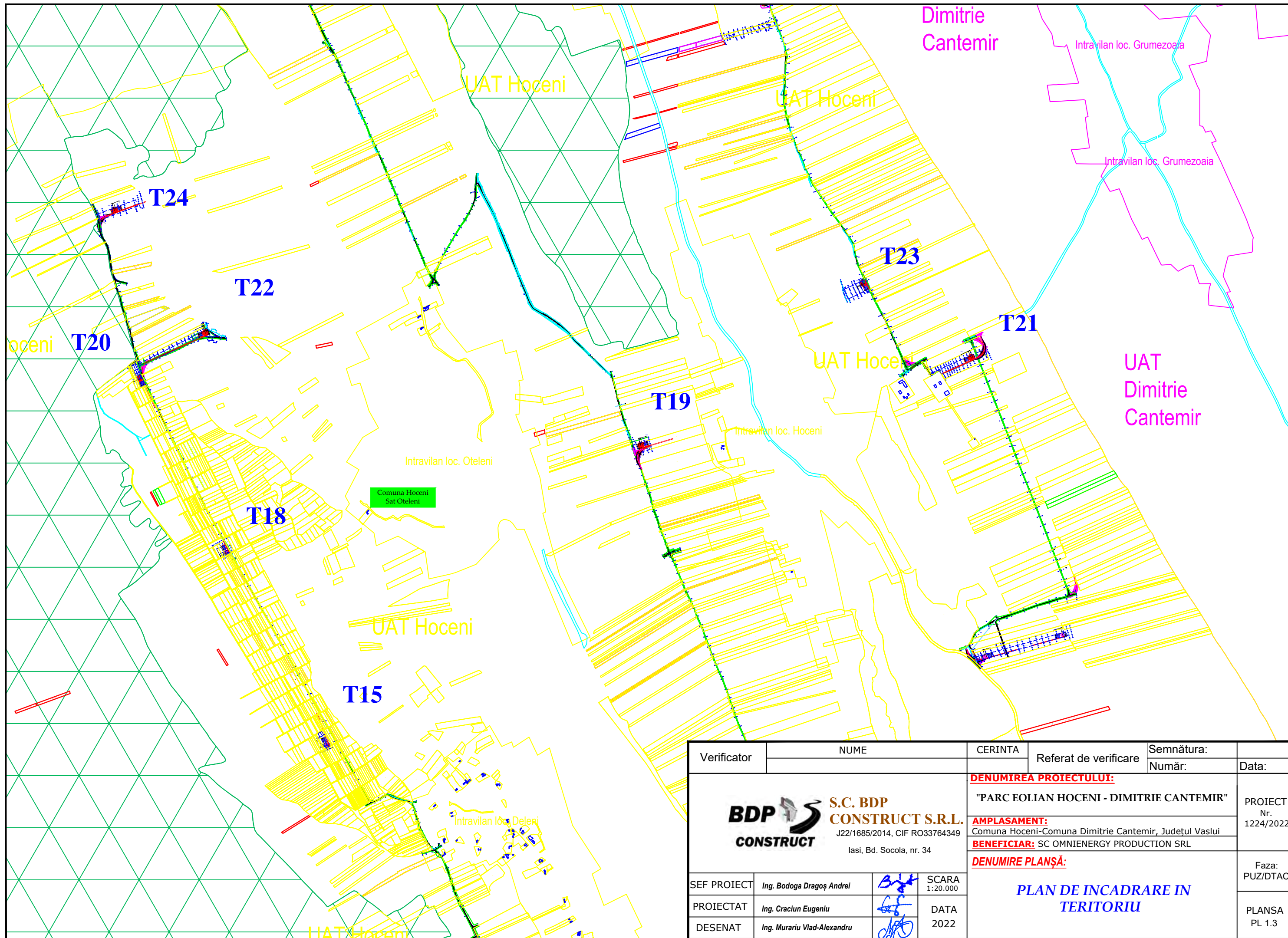



Verificator	NUME	CERINTA	Referat de verificare	Semnătura: Număr:	Data:
 S.C. BDP CONSTRUCT S.R.L. J22/1685/2014, CIF RO33764349 Iasi, Bd. Socola, nr. 34		DENUMIREA PROIECTULUI:			PROIECT Nr. 1224/2022
		"PARC EOLIAN HOCENI - DIMITRIE CANTEMIR"			
		AMPLASAMENT: Comuna Hoceni-Comuna Dimitrie Cantemir, Judetul Vaslui BENEFICIAR: SC OMNIENERGY PRODUCTION SRL DENUMIRE PLANȘĂ:			Faza: PUZ/DTAC PLANSA PL 1.2
SEF PROIECT	Ing. Bodoș Dragoș Andrei		SCARA 1:20.000	PLAN DE INCADRARE IN TERITORIU	
PROIECTAT	Ing. Craciun Eugeniu		DATA 2022		
DESEMAT	Ing. Murariu Vlad-Alexandru				

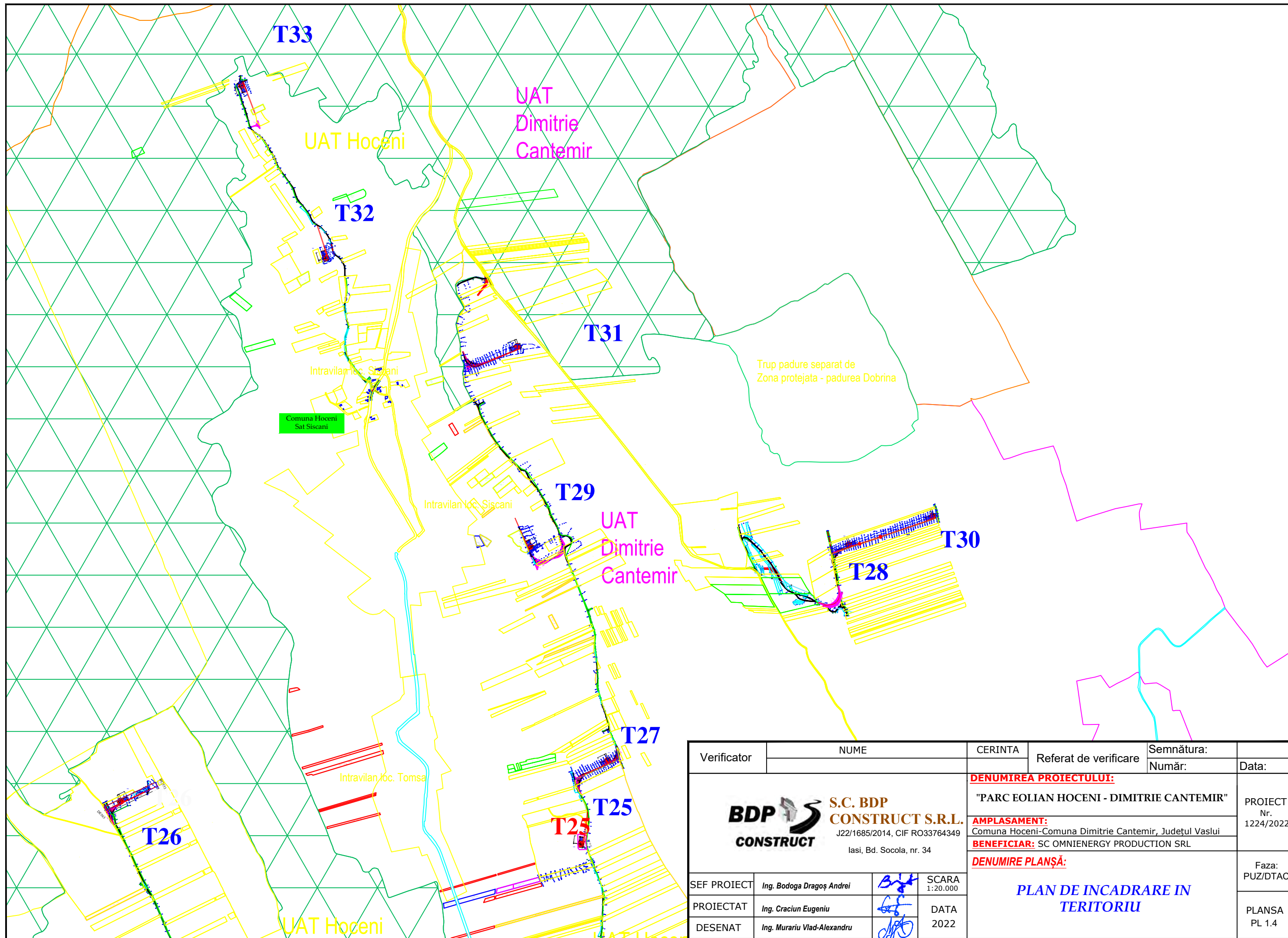

Verificator	NUME		CERINTA	Referat de verificare	Semnătura: Număr:	Data:
	 S.C. BDP CONSTRUCT S.R.L. J22/1685/2014, CIF RO33764349 Iasi, Bd. Socola, nr. 34		DENUMIREA PROIECTULUI: "PARC EOLIAN HOCENI - DIMITRIE CANTEMIR" AMPLASAMENT: Comuna Hoceni-Comuna Dimitrie Cantemir, Judetul Vaslui BENEFICIAR: SC OMNIENERGY PRODUCTION SRL		PROIECT Nr. 1224/2022	
SEF PROIECT	Ing. Bodoș Dragoș Andrei		SCARA 1:20.000	PLAN DE INCADRARE IN TERITORIU		Faza: PUZ/DTAC
PROIECTAT	Ing. Craciun Eugeniu		DATA 2022			PLANSA PL 1.3
DESENAT	Ing. Murariu Vlad-Alexandru					



Verificator	NUME	CERINTA	Referat de verificare	Semnătura: Număr:	Data:
 S.C. BDP CONSTRUCT S.R.L. J22/1685/2014, CIF RO33764349 Iasi, Bd. Socola, nr. 34		DENUMIREA PROIECTULUI: "PARC EOLIAN HOCENI - DIMITRIE CANTEMIR"			PROIECT Nr. 1224/2022
		AMPLASAMENT: Comuna Hoceni-Comuna Dimitrie Cantemir, Judetul Vaslui BENEFICIAR: SC OMNIENERGY PRODUCTION SRL			
SEF PROIECT		Ing. Bodoaga Dragoş Andrei		SCARA 1:20.000	Faza: PUZ/DTAC
PROIECTAT		Ing. Craciun Eugeniu		DATA 2022	PLAN DE INCADRARE IN TERITORIU PLANSĂ PL 1.4
DESENAT		Ing. Murariu Vlad-Alexandru	